

# *Artis*<sup>®</sup> *SE*

STAGE PIANO



## Musician's Guide

**KURZWEIL<sup>®</sup>**

Part Number 910570-002 - Rev. B

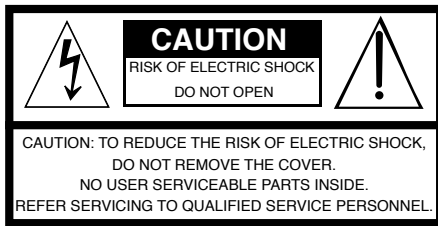

The lightning flash with the arrowhead symbol, within an equilateral triangle is intended to alert the user to the presence of uninsulated "dangerous voltage" within the product's enclosure that may be of sufficient magnitude to constitute a risk of electric shock to persons.



The exclamation point within an equilateral triangle is intended to alert the user to the presence of important operating and maintenance (servicing) instructions in the literature accompanying the product.

## IMPORTANT SAFETY & INSTALLATION INSTRUCTIONS

### INSTRUCTIONS PERTAINING TO THE RISK OF FIRE ELECTRIC SHOCK , OR INJURY TO PERSONS

**WARNING:** When using electric products, basic precautions should always be followed, including the following:

1. Read all the Safety and Installation Instructions and Explanation of Graphic Symbols before using the product.
2. This product must be grounded. If it should malfunction or break down, grounding provides a path of least resistance for electric current to reduce the risk of electric shock. This product is equipped with a power supply cord having an equipment-grounding conductor and a grounding plug. The plug must be plugged into an appropriate outlet which is properly installed and grounded in accordance with all local codes and ordinances.
 

**DANGER:** Improper connection of the equipment-grounding conductor can result in a risk of electric shock. Do not modify the plug provided with the product – if it will not fit the outlet, have a proper outlet installed by a qualified electrician. Do not use an adaptor which defeats the function of the equipment-grounding conductor. If you are in doubt as to whether the product is properly grounded, check with a qualified serviceman or electrician.
3. Do not use this product near water – for example, near a bathtub, washbowl, kitchen sink, in a wet basement, or near a swimming pool, or the like.
4. This product should only be used with a stand or cart that is recommended by the manufacturer.
5. This product, either alone or in combination with an amplifier and speakers or headphones, may be capable of producing sound levels that could cause permanent hearing loss. Do not operate for a long period of time at a high volume level or a level that is uncomfortable. If you experience any hearing loss or ringing in the ears, you should consult an audiologist.
6. This product should be located so that its location or position does not interfere with its proper ventilation.
7. The product should be located away from heat sources such as radiators, heat registers, or other products that produce heat.
8. The product should be connected to a power supply only of the type described in the operating instructions or as marked on the product.
9. This product may be equipped with a polarized line plug (one blade wider than the other). This is a safety feature. If you are unable to insert the plug into the outlet, contact an electrician to replace your obsolete outlet. Do not defeat the safety purpose of the plug.
10. The power supply cord of the product should be unplugged from the outlet when left unused for a long period of time. When unplugging the power supply cord, do not pull on the cord, but grasp it by the plug.
11. Care should be taken so that objects do not fall and liquids are not spilled into the enclosure through openings.
12. The product should be serviced by qualified service personnel when:
  - A. The power supply, power cord or plug have been damaged;
  - B. Objects have fallen, or liquid has been spilled into the product;
  - C. The product has been exposed to rain;
  - D. The product does not appear to be operating normally or exhibits a marked change in performance;
  - E. The product has been dropped, or the enclosure damaged.
13. Do not attempt to service the product beyond that described in the user maintenance instructions. All other servicing should be referred to qualified service personnel.
14. **WARNING:** Do not place objects on the product's power supply cord, or place the product in a position where anyone could trip over, walk on, or roll anything over cords of any type. Do not allow the product to rest on or be installed over cords of any type. Improper installations of this type create the possibility of a fire hazard and/or personal injury.

## RADIO AND TELEVISION INTERFERENCE

**WARNING:** Changes or modifications to the instrument not expressly approved by Young Chang could void your authority to operate the instrument.

**IMPORTANT:** When connecting this product to accessories and/or other equipment use only high quality shielded cables.

**NOTE:** This instrument has been tested and found to comply with the limits for a Class B digital device, pursuant to Part 15 of the FCC Rules. These limits are designed to provide reasonable protection against harmful interference in a residential installation. This instrument generates, uses, and can radiate radio frequency energy and, if not installed and used in accordance with the instructions, may cause harmful interference to radio communications. However, there is no guarantee that interference will not occur in a particular installation. If this instrument does cause harmful interference to radio or television reception, which can be determined by turning the instrument off and on, the user is encouraged to try to correct the interference by one or more of the following measures:

- Reorient or relocate the receiving antenna.

- Increase the separation between the instrument and the receiver.
- Connect the instrument into an outlet on a circuit other than the one to which the receiver is connected.
- If necessary consult your dealer or an experienced radio/television technician for additional suggestions.

The normal function of the product may be disturbed by strong electromagnetic interference. If so, simply reset the product to resume normal operation by following the instructions in the manual. If normal function does not resume, please use the product in another location.

### NOTICE

This apparatus does not exceed the Class B limits for radio noise emissions from digital apparatus set out in the Radio Interference Regulations of the Canadian Department of Communications.

### AVIS

Le présent appareil numérique n'émet pas de bruits radioélectriques dépassant les limites applicables aux appareils numériques de la class B prescrites dans le Règlement sur le brouillage radioélectrique édicté par le ministère des Communications du Canada.

## SAVE THESE INSTRUCTIONS

# IMPORTANT SAFETY INSTRUCTIONS

- 1) Read these instructions.
- 2) Keep these instructions.
- 3) Heed all warnings.
- 4) Follow all instructions.
- 5) Do not use this apparatus near water.
- 6) Clean only with dry cloth.
- 7) Do not block any of the ventilation openings. Install in accordance with the manufacturer's instructions.
- 8) Do not install near any heat sources such as radiators, heat registers, stoves, or other apparatus (including amplifiers) that produce heat.
- 9) Do not defeat the safety purpose of the polarized or grounding-type plug. A polarized plug has two blades with one wider than the other. A grounding type plug has two blades and a third grounding prong. The wide blade or the third prong are provided for your safety. If the provided plug does not fit into your outlet, consult an electrician for replacement of the obsolete outlet
- 10) Protect the power cord and power supply adapter from being walked on or pinched, particularly at plugs, convenience receptacles, and the point where they exit from the apparatus.



- 11) Only use power adapters and attachments/accessories specified by the manufacturer.
- 12) Use only with a cart, stand, tripod, bracket, or table specified by the manufacturer, or sold with the apparatus. When a cart is used, use caution when moving the cart/apparatus combination to avoid injury from tip-over.
- 13) Unplug this apparatus during lightning storms or when unused for long periods of time.
- 14) Refer all servicing to qualified service personnel. Servicing is required when the apparatus has been damaged in any way, such as power-supply cord or plug is damaged, liquid has been spilled or objects have fallen into the apparatus, the apparatus has been exposed to rain or moisture, does not operate normally, or has been dropped.

**Warning:** To reduce the risk of fire or electric shock, do not expose this apparatus to rain or moisture. Do not expose this equipment to dripping or splashing and ensure that no objects filled with liquids, such as vases, are placed on the equipment.

To completely disconnect this equipment from the AC Mains, disconnect the power supply cord plug from the AC receptacle.

©2018 Young Chang Co., Ltd. All rights reserved. Kurzweil® is a product line of Young Chang Co., Ltd. Kurzweil®, Young Chang®, V. A. S. T.®, and Artis SE™ are trademarks of Young Chang Co., Ltd. All other trademarks and copyrights are property of their respective companies. Product features and specifications are subject to change without notice.

You may legally print up to two (2) copies of this document for personal use. Commercial use of any copies of this document is prohibited. Young Chang Co. retains ownership of all intellectual property represented by this document.

# Kurzweil International Contacts

Contact the Kurzweil office listed below to locate your local Kurzweil representative.

## US Customers:

American Music & Sound  
925 Broadbeck Dr #220  
Newbury Park, CA 91320

Tel: 800-431-2609

Fax: 818-597-0411

Email: [info@americanmusicandsound.com](mailto:info@americanmusicandsound.com)

## Customers outside the US:

Young Chang Co., LTD.  
178-55, Gajwa-Dong, Seo-Ku  
Incheon, Korea Post Code: 404-714

Tel: +82-32-570-1576

Fax: +82-32-576-2340



[www.kurzweil.com](http://www.kurzweil.com)



[support@kurzweil.com](mailto:support@kurzweil.com)



[www.facebook.com/kurzweilmusicsystems/](http://www.facebook.com/kurzweilmusicsystems/)



[www.twitter.com/KurzweilMusic](http://www.twitter.com/KurzweilMusic)



[www.youtube.com/user/KurzweilTutorials](http://www.youtube.com/user/KurzweilTutorials)

# Contents

Kurzweil International Contacts.....	iv
<b>Introducing Artis SE .....</b>	<b>1-1</b>
<b>Main Features .....</b>	<b>1-1</b>
Sound sources .....	1-2
Keyboard and Controllers .....	1-2
Pedals (Optional) .....	1-2
<b>Keeping the Artis SE up to date.....</b>	<b>1-3</b>
<b>Do You Have Everything? .....</b>	<b>1-3</b>
<b>Music Rack (Optional).....</b>	<b>1-3</b>
<b>Getting Started .....</b>	<b>2-1</b>
<b>Before You Start.....</b>	<b>2-1</b>
<b>Quick Start .....</b>	<b>2-1</b>
Using Artis SE .....	2-2
<b>Start Up Details: The Rear Panel.....</b>	<b>2-3</b>
The DC Power Adapter .....	2-3
The USB Ports .....	2-3
The MIDI (IN and OUT) Ports .....	2-4
The Pedal Jacks.....	2-4
The SW1 (Sustain) and SW2 Jacks .....	2-4
The CC Jack .....	2-4
The Headphones Jack .....	2-5
The Audio In Jack.....	2-5
<b>Connecting the Power Adapter .....</b>	<b>2-5</b>
<b>Connecting to Your Audio System.....</b>	<b>2-5</b>
The Audio Out Jacks (Right and Left/Mono) .....	2-5
<b>Connecting Pedals .....</b>	<b>2-7</b>
Connecting a Single Switch Pedal .....	2-7
Connecting a Dual Switch Pedal.....	2-8
Connecting a Half Damper Pedal.....	2-9
Connecting a Continuous Control Pedal .....	2-10
<b>Connecting MIDI .....</b>	<b>2-11</b>
Basic MIDI Hookup .....	2-11
Connecting More Sound Modules.....	2-11

Connecting to a Computer Sequencer .....	2-12
<b>Selecting Programs and Multis .....</b>	<b>2-13</b>
<b>Features of the Artis SE .....</b>	<b>3-1</b>
<b>Powering Up Defaults .....</b>	<b>3-1</b>
Parameters Reset To Defaults At Power-On .....	3-1
Parameters Remembered After Power-On .....	3-1
<b>The Front Panel .....</b>	<b>3-2</b>
<b>Real Time Controls .....</b>	<b>3-3</b>
Pitch Wheel .....	3-3
Modulation Wheel .....	3-3
Programmable Switches (SW1 and SW2) .....	3-3
Foot Switches and Controllers .....	3-4
<b>Audio Level Controls .....</b>	<b>3-4</b>
Volume Slider .....	3-4
Audio In .....	3-4
Master EQ .....	3-4
Sliders and Filter-FX button .....	3-5
ZONE ON/OFF Buttons .....	3-6
<b>Mode Buttons .....</b>	<b>3-6</b>
Multi Button .....	3-7
Program Button .....	3-7
Global Button .....	3-7
Storage Button .....	3-7
Edit Button (Multi Edit Mode) .....	3-7
Save Button .....	3-8
<b>Function Buttons .....</b>	<b>3-8</b>
Sound .....	3-8
Split .....	3-8
Layer .....	3-9
Transpose +/- and Octave .....	3-9
<b>Favorites .....</b>	<b>3-10</b>
<b>Category and sound selection .....</b>	<b>3-10</b>
CATEGORY button .....	3-10
USER button .....	3-10
A/B Bank button .....	3-11
<b>Navigation .....</b>	<b>3-11</b>
The LCD Display .....	3-11
(-) and (+) Value Buttons .....	3-12
Param / Channel Buttons .....	3-12
Alpha Wheel .....	3-12
ASSIGN and EXIT Buttons .....	3-12

<b>Double Button Presses .....</b>	<b>3-13</b>
Value Jump .....	3-13
Parameter Jump.....	3-13
Reset Transposition .....	3-13
Program Demo.....	3-14
Demo.....	3-14
Panic .....	3-14
Assign .....	3-14
Assign + Zone (1–4) Button.....	3-14
Assign + Controller .....	3-15
Assign + Keyboard key.....	3-15
<b>Terminology.....</b>	<b>4-1</b>
<b>The Operating Modes .....</b>	<b>5-1</b>
<b>Multi Mode.....</b>	<b>5-1</b>
<b>Program Mode .....</b>	<b>5-2</b>
<b>Global Mode .....</b>	<b>5-2</b>
<b>Storage Mode.....</b>	<b>5-2</b>
<b>Multi Edit Mode .....</b>	<b>5-2</b>
<b>Functions .....</b>	<b>5-3</b>
The Sound Function.....	5-3
The Split Function .....	5-3
The Layer Function .....	5-3
Transpose Functions.....	5-3
Program and Song Demo Functions.....	5-3
<b>Program Mode .....</b>	<b>6-1</b>
<b>About Program Mode.....</b>	<b>6-1</b>
<b>Selecting Programs.....</b>	<b>6-1</b>
Program Demo.....	6-2
The Display .....	6-2
Pop Up Messages .....	6-2
Alpha Wheel & – and + Value Buttons .....	6-3
Value Jump Buttons .....	6-3
Category & Program/Multi Buttons.....	6-4
Choosing Category Default Programs .....	6-5
Choosing Favorites .....	6-5
<b>Transposition .....</b>	<b>6-5</b>
<b>Parameter Assignments .....</b>	<b>6-6</b>
<b>The Split Function .....</b>	<b>6-6</b>
Split Key.....	6-8

Split Transpose .....	6-8
Saving a Split .....	6-8
<b>The Layer Function .....</b>	<b>6-8</b>
Layer Volume .....	6-9
Layer Transpose .....	6-10
Saving a Layer .....	6-10
<b>Changing the Transmit MIDI Channel.....</b>	<b>6-10</b>
<b>Panic .....</b>	<b>6-11</b>
<b>Saving User Programs .....</b>	<b>6-11</b>
Changing ID Numbers.....	6-12
Naming a User Program .....	6-12
Locating a saved User Program.....	6-12
<b>Multi Mode .....</b>	<b>7-1</b>
<b>About Multi Mode .....</b>	<b>7-1</b>
<b>About Zones.....</b>	<b>7-1</b>
<b>Selecting Multis .....</b>	<b>7-2</b>
The Display .....	7-2
Alpha Wheel and <b>—</b> & <b>+</b> Value Buttons .....	7-3
Value Jump Buttons .....	7-3
Category & Program/Multi Buttons.....	7-3
Choosing Category Default Multis.....	7-4
Choosing Favorites .....	7-4
<b>Transposition .....</b>	<b>7-4</b>
<b>The Split Function .....</b>	<b>7-5</b>
Split Program .....	7-5
Split Volume.....	7-6
Split Key.....	7-6
Saving a Split .....	7-6
<b>The Layer Function .....</b>	<b>7-6</b>
Layer Program .....	7-7
Layer Volume.....	7-7
Layer Transpose.....	7-7
Saving a Layer .....	7-8
<b>Saving User Multis .....</b>	<b>7-8</b>
Changing ID Numbers.....	7-8
Naming a User Multi.....	7-9
Completing a User Multi Save.....	7-9



<b>Multi Edit Mode.....</b>	<b>8-1</b>
<b>About Multi Edit Mode.....</b>	<b>8-1</b>
<b>The Parameters List .....</b>	<b>8-2</b>
<b>Selecting Parameters .....</b>	<b>8-4</b>
The Display .....	8-4
Scrolling Messages.....	8-4
Param/Channel Buttons.....	8-4
Alpha Wheel and Value buttons .....	8-4
Value Jump Buttons .....	8-4
Param Jump Buttons.....	8-4
Assign .....	8-5
Assign + Zone (1–4) Button.....	8-5
Assign + controller .....	8-5
Assign + key .....	8-5
<b>The Zone-specific Parameters .....</b>	<b>8-5</b>
Local Program (Local Prog) .....	8-5
Channel.....	8-6
Destination (Dest) .....	8-6
Zone Status (Status) .....	8-6
Entry Volume (EntryVol).....	8-6
Entry Pan .....	8-7
Aux Send Level (AuxSendLvl) .....	8-7
Zone Channel Effects (ZnChanFX).....	8-7
Transpose (Xpose).....	8-7
Low Key (LoKey).....	8-7
High Key (HiKey).....	8-7
Low Velocity (LoVel).....	8-8
High Velocity (HiVel).....	8-8
Notemap.....	8-8
MIDI Bank .....	8-8
MIDI Program.....	8-9
Entry Program Change (EntryPrgChg) .....	8-10
Bank Mode.....	8-10
Bend Range Down (BendRngDwn) .....	8-10
Bend Range Up (BendRngUp).....	8-10
Continuous Controller Parameters.....	8-11
Destination (Dest) .....	8-11
Controlling Program Parameter Assignments from Multi Mode	8-13
Entry Value .....	8-13
Exit Value.....	8-13
<b>The Pedal Switch &amp; Switch Button Parameters .....</b>	<b>8-13</b>
Mode.....	8-14
Destination (Dest).....	8-14

On Value (OnVal).....	8-14
Off Value (OffVal).....	8-14
Entry State.....	8-14
Exit State.....	8-14
<b>About Auxiliary Effects.....</b>	<b>8-15</b>
<b>Common Parameters.....</b>	<b>8-15</b>
Aux FX.....	8-15
Aux FX Channel (AuxFXCh).....	8-15
KB3 Channel.....	8-16
Tempo.....	8-16
<b>Saving User Multis.....</b>	<b>8-16</b>
<b>Global Mode.....</b>	<b>9-1</b>
<b>Selecting and Editing Parameters.....</b>	<b>9-2</b>
<b>The Global Parameters.....</b>	<b>9-3</b>
Tune.....	9-3
Velocity Map.....	9-3
FX Select (FXSel).....	9-4
Auto Power Off.....	9-4
Auto Power Off Time.....	9-4
Pedal Noise.....	9-4
Hard Reset?.....	9-5
Soft Reset?.....	9-5
Bank Select (BankSel).....	9-6
Program Change (ProgChg).....	9-6
Channel Enable.....	9-6
Local Keyboard Channel (LclKbdChan).....	9-6
Program Mode.....	9-7
Multi Mode.....	9-7
Sysex ID.....	9-7
Objects/OS.....	9-7
Delete Objects?.....	9-8
<b>Storage Mode.....</b>	<b>10-1</b>
Device.....	10-1
Store?.....	10-2
Load (Overwrite)?.....	10-3
Load (Fill)?.....	10-4

**System Mode (Boot Loader) ..... 11-1**

- System Mode Buttons..... 11-2
- Run Artis SE..... 11-2
- Update Software ..... 11-2
  - Update.....11-2
  - Restore.....11-3
- Run Diagnostics ..... 11-4
- System Reset..... 11-4
- File Utilities ..... 11-4

**Troubleshooting ..... 12-1**

- Maintenance..... 12-1
- Common Problems..... 12-1
  - Power Problems..... 12-1
  - Powers up, Display is Blank..... 12-2
  - Audio Problems..... 12-2
- MIDI Problems..... 12-4
- Pedal Problems..... 12-5
  - Switch Pedal Problems ..... 12-5
  - Continuous Control and Half Damper Pedal Problems..... 12-5
- If None of the Above..... 12-6
  - Restoring Factory Defaults..... 12-6
  - Diagnostics..... 12-7

**MIDI Implementation .....A-1**

**Physical Specifications .....B-1**

**Factory Programs .....C-1**

**Factory Multis.....D-1**

**Index..... I-1**

# Chapter 1

## Introducing Artis SE

Congratulations on your purchase of the Kurzweil Artis SE® Stage Piano!

This manual will help you get acquainted with your new instrument. Be sure to keep the manual on hand as you continue to familiarize yourself with the features and functions of the Artis SE.

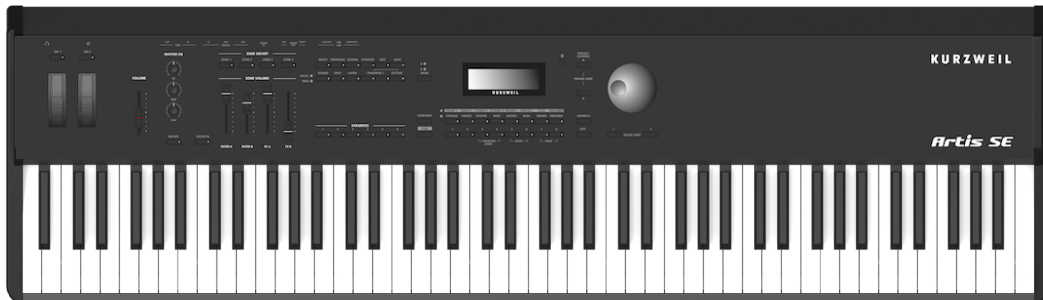

## Main Features

The Artis SE Stage Piano is the beginning of the next generation of Kurzweil's professional performance instruments. It boasts hundreds of excellent preset sounds (including the new German D Grand EXP set of piano sounds and the Enhanced Kore64 ROM) already on-board and ready to be played with 128 voice polyphony.

The Artis SE is also a very capable MIDI controller ideally suited for controlling additional sound modules and as input to a sequencer.

## Sound sources

- 256 Factory Programs divided into 16 Categories
- 256 User IDs to save your own Programs
- 128 Factory Multis and 256 User IDs to save your own Multis
- MP3 player audio input jack
- Full 128 voices of polyphony
- KB3 organ simulations with 4 sliders as drawbars

## Keyboard and Controllers

The Artis SE has an 88-key fully-weighted hammer action keyboard that provides you with a piano-like feel without adding excessive weight to the instrument. The array of physical controllers includes:

- 4 assignable sliders, with shift function to control 8 parameters
- 2 programmable switches
- Pitch and Modulation wheels
- MIDI In and Out jacks
- 2 USB ports for MIDI and file transfers
- 2 jacks for optional switch pedals
- 1 jack for an optional continuous controller pedal

## Pedals (Optional)

As described above, the Artis SE has three jacks on the rear panel for optional pedal controllers. Two jacks for switch pedals, which are typically used to control two-state (i.e., on / off) parameters such as sustain, sostenuto, and mute Zone. The third jack is for a continuous control (or CC) pedal typically used to control multi-state (i.e., “continuous”) parameters such as volume or wah.

Your Kurzweil dealer stocks the following pedals:

- KP-1            Single piano-style switch pedal
- KP-1H        Single piano-style Half Damper pedal
- CC-1           Continuous pedal

## Keeping the Artis SE up to date

Be sure to check the Kurzweil Music Systems website at <http://www.kurzweil.com> for new documentation and the latest software updates for Artis SE.

## Do You Have Everything?

Your Artis SE package should contain the following in addition to your instrument:

- Power adapter and cable
- Switch pedal
- USB cable (Type-A-to-Type-B)
- 4 self adhesive feet (see page 2-1)
- Artis SE *Getting Started* Guide

If you are missing any of these components, please contact your Kurzweil / Young Chang dealer to get them.

## Music Rack (Optional)

The optional KMR2 Music Rack attachment is a holder for sheet music or a computer tablet device. Contact your Kurzweil dealer for the KMR2 Music Rack.

Please refer to the instructions that come with the KMR2 on attaching the music rack to the Artis SE.

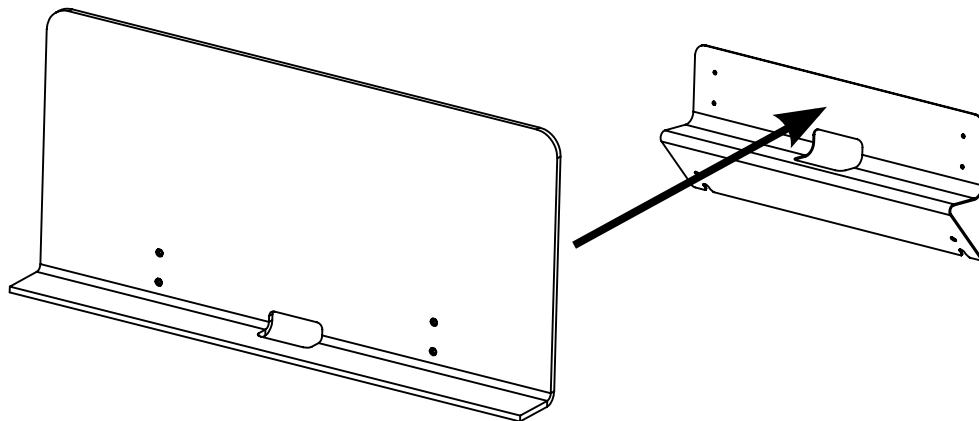

# Chapter 2

## Getting Started

Getting a new keyboard is always exciting and the first thing most users want to do is unpack the keyboard and check things out. This chapter will help you hook up the Artis SE to your sound system and MIDI system, give you a quick overview, and show you how to get some sound out of the Artis SE.

### Before You Start...

Don't connect anything until you make sure the Artis SE is properly and safely situated. If your Artis SE keyboard has been out in the cold, give it time to warm up to room temperature before starting it, since condensation may have formed inside.

### Quick Start

1. Set the keyboard on a hard, flat, level surface.
2. Four adhesive-backed rubber feet are provided with Artis SE. Carefully turn the keyboard over onto a soft surface, remove the paper backing from the rubber feet and attach them.

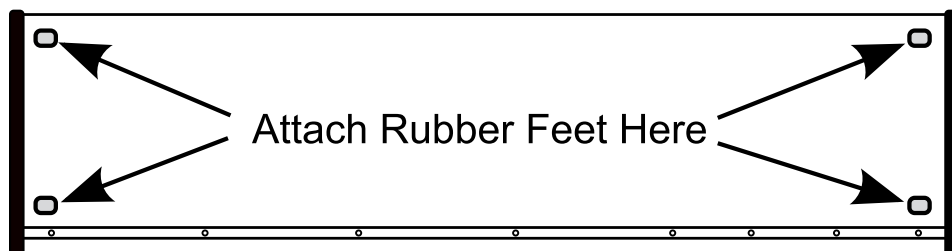

**NOTE :** Unless the instrument will always be used with a keyboard stand, attachment of the rubber feet is strongly advised. Otherwise protruding screws will scratch the tabletop and may increase the key action sound.

## Getting Started

---

### Quick Start

3. Connect the AC power adapter to the Artis SE. Before plugging the power adapter's cable into a power outlet, check that the power outlet is compatible with the Artis SE. The Artis SE runs on AC power and works with voltages from 90 - 260 volts at 50–60 Hz. The voltage level is detected and set automatically by the power supply. If your power outlet is not within these ranges it is recommended you use an appropriate adapter.
4. Plug the power cable into the wall.
5. Plug the Switch Pedal into the marked SW1 (Sustain) Pedal jack on the Artis SE rear panel.
6. Connect stereo headphones to the headphone jack on the rear left panel, or connect the audio outputs to your mixer or amplifier inputs using standard (1/4-inch) audio cables (use the Left out for mono). Balanced (“TRS” or “Stereo”) cables are recommended if your mixer or amp supports balanced inputs.
7. Make sure your sound system is at a safe volume level. Also make sure that the Artis SE MASTER VOLUME slider (on the far left side of the front panel) is all the way down.

## Using Artis SE

1. Power up the Artis SE, and then raise the MASTER VOLUME slider, and mixer/amp volume. Your Artis SE keyboard starts up in Multi Mode by default. Press one of the buttons under the “Mode” label to the right of the display to switch Modes.

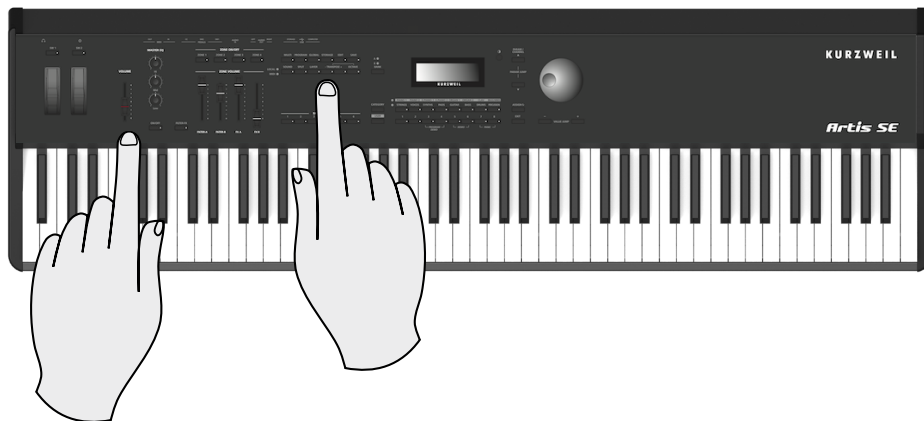

### **Volume      MODE selection**

2. If you are connected to a mixing board and hear distortion, reduce the gain level on your mixing board, or use the pad (*a switch that decreases the input audio signal level, typically by 20dB*) if it has one.
3. Scroll through the Programs using the Alpha Wheel, the Previous and Next buttons, or press a Category button to audition the sounds in Artis SE.



## Start Up Details: The Rear Panel

The power switch and Artis SE connections are located on the rear panel.

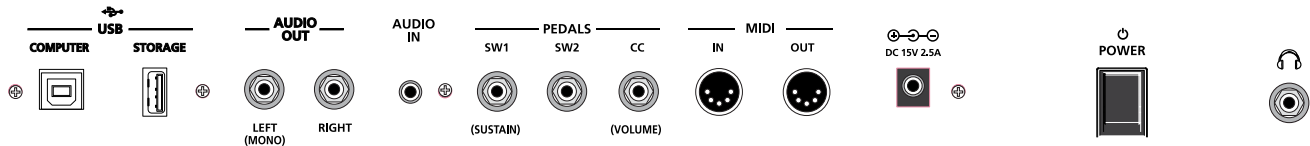

### The DC Power Adapter

Use the provided DC power adapter to connect the Artis SE to a standard AC power source.

### The USB Ports

Use the USB ports to connect the Artis SE to a computer/tablet in order to do the following:

- Use the Artis SE as a MIDI controller to play software instruments on a computer.
- Use a computer program to sequence multitrack songs on the Artis SE.
- Use a computer/tablet to manage the user data contents of the Artis SE.
- Update the software and sounds of the Artis SE.
- Store custom Programs and Multis on a USB flash drive.

Be sure to check the Kurzweil Music Systems website at [www.kurzweil.com](http://www.kurzweil.com) for new documentation and software updates before using your new instrument.

## Getting Started

### Start Up Details: The Rear Panel

## The MIDI (IN and OUT) Ports

Use the MIDI ports to communicate with other MIDI modules and controllers. The OUT port is the MIDI transmitting port, and the IN port is the MIDI receiving port.

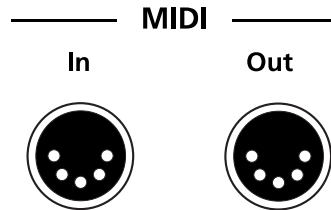

## The Pedal Jacks

Use the three pedal jacks to connect controller pedals to Artis SE.

### The SW1 (Sustain) and SW2 Jacks

Use the pedal jacks to connect switch pedals. A switch pedal is a physical controller typically used to control two-state (i.e., “on / off”) parameters, such as sustain, sostenuto, and Mute Zone.

It is possible to connect up to 2 dual switch pedals having a single stereo plug into the SW1 and SW2 jacks, (see Connecting a Dual Switch Pedal on page 2-8) or up to 2 half damper pedals having stereo jacks.



**NOTE :** It is not recommended to plug CC pedals into the SW inputs. Due to the flexible switch pedal support, CC pedals may not operate as expected in these inputs.

### The CC Jack

Use the CC pedal jack to connect a continuous control (or CC) pedal. A CC pedal is a physical controller typically used to control multi-state (i.e., “continuous”) parameters such as volume or wah.



**NOTE :** Only CC pedals should be connected to the CC pedal input.

For more information on connecting pedals, see page 2-6.

## The Headphones Jack

Use the HEADPHONES jack located on the rear/left of the instrument, behind the Pitch and Modulation wheels, to listen to the Artis SE on stereo headphones. When headphones are plugged in, sound still comes through the Left and Right audio jacks. You will need a 1/8-inch-to-1/4-inch adapter in order to use headphones that have a smaller mini plug connector.

## The Audio In Jack

A 1/8" sized stereo audio jack labelled AUDIO IN on the back panel of the Artis SE allows you to play an MP3 player or other audio source through the Artis SE. There is no input volume control for this on the Artis SE itself, so you should control the mix volume of the Audio Input from the external audio player itself.

## Connecting the Power Adapter

The Artis SE runs on standard AC power using a DC power adapter. With the rear panel power switch in the Off position, connect the DC power adapter to the Artis SE. A power cord is included to connect the adapter to an AC outlet. Before plugging the cable into the AC outlet, check that the power is compatible with the Artis SE (with voltages from 90 - 260 volts at 50–60 Hz).

## Connecting to Your Audio System

### The Audio Out Jacks (Right and Left/Mono)

With the the level on your sound system turned down, connect the Artis SE analog audio outputs to your sound system using a pair of balanced (TRS or "stereo") or unbalanced (TS or "mono") audio cables. Unbalanced cables will always work, but if you're going into balanced inputs, use balanced cables for a better signal-to-noise ratio and a bit more volume. The Artis SE analog outputs are balanced.

You'll find two 1/4-inch balanced audio output jacks on the rear panel. Connect one end of each audio cable to your mixing board or PA system inputs, and connect the other end to the jacks marked Left (Mono) and Right on the rear panel of the Artis SE. If you have only one input available, use the Artis SE's Left (Mono) output to get the full signal in mono.

## Getting Started

### Connecting Pedals

**Artis SE connected to powered speakers and headphones**

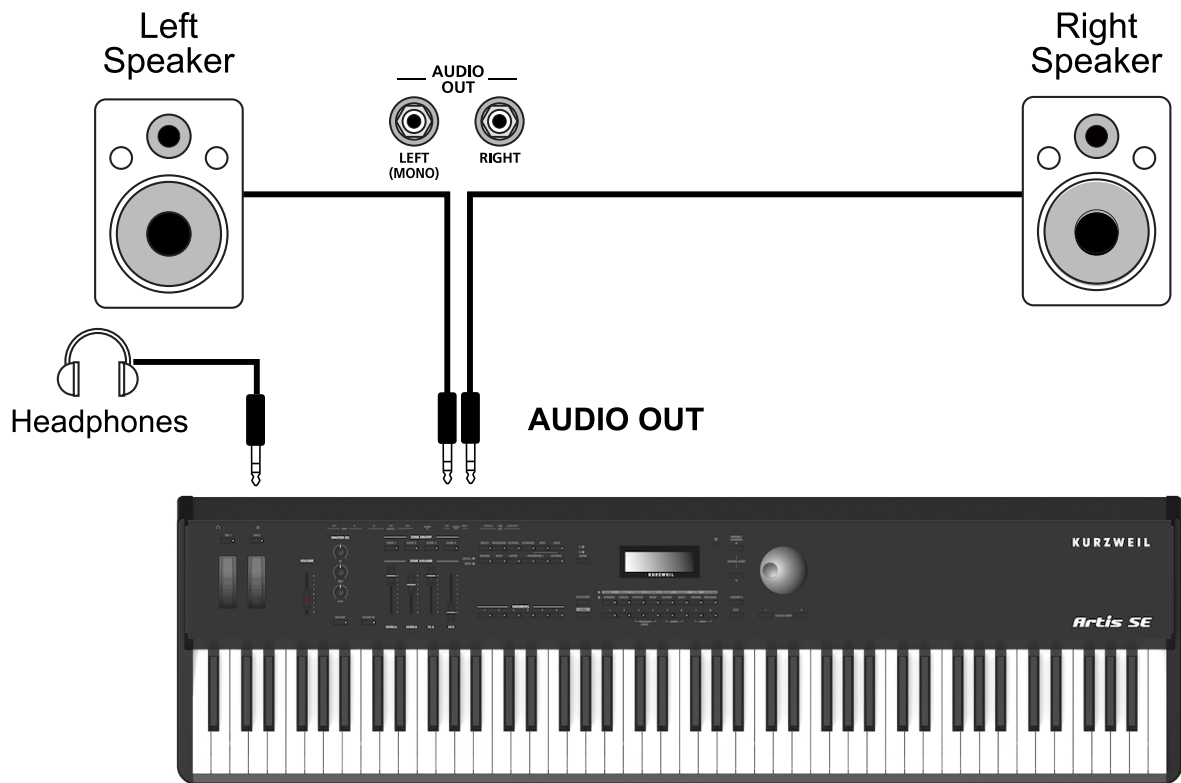

**Artis SE connected to a mixer, powered speakers and headphones**

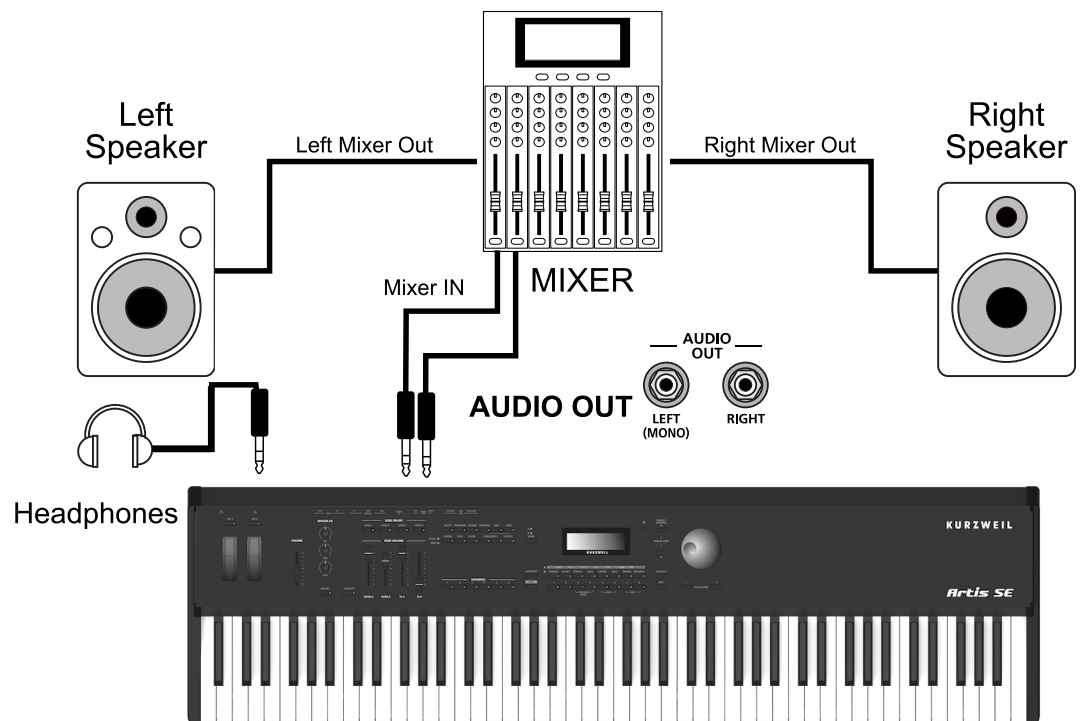

## Connecting Pedals

Plug your switch, dual switch, half-damper or continuous control pedals into the corresponding jacks on Artis SE rear panel. We recommend using the Kurzweil pedals described in Pedals (Optional) on page 1-2. However you can use almost any switch or continuous control pedal that adheres to the following specifications.

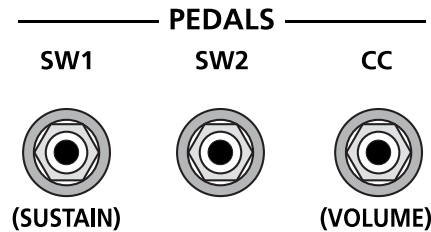

<b>Switch Pedals</b>	1/4 inch tip-sleeve (mono) plug or, 1/4 inch tip-ring-sleeve plug configured as dual switches (TS and RS) or 2 terminal continuous pedal (half-damper).
<b>Continuous Control (CC) Pedals</b>	10 kΩ linear-taper potentiometer, 1/4 inch tip-ring-sleeve (stereo) plug with the wiper connected to the tip.

Pedals are all independently assignable within each Zone of every Multi.

Here are the default control settings for the three pedals used by Artis SE:

<b>SW 1 Pedal</b>	Sustain (MIDI 64)
<b>SW 2 Pedal</b>	Sostenuto (MIDI 66)
<b>CC Pedal</b>	Expression (MIDI 11)



**NOTE :** Ensure that pedals are plugged in before powering up the Artis SE and do not step on the switch pedals when powering up, as the pedal type and state of the pedal is detected as part of the power up sequence.

### Connecting a Single Switch Pedal

When a single switch pedal is plugged into the SW1 Pedal jack on the rear panel, a single switch pedal will, by default, act like a sustain pedal. When a single switch pedal is plugged into the SW2 Pedal jack, the single switch pedal will, by default, act like a sostenuto pedal.

This can be changed by editing, as described in Multi Mode on page 7-1.

## Getting Started

### Connecting Pedals

If you are not using a Kurzweil switch pedal, make sure it's connected before you turn on the Artis SE. This ensures that the pedal will work properly (it might function in reverse—off when it's down and on when it's up—if you turn on your Artis SE before plugging in the pedal). Similarly, don't press any of your switch pedals while powering up, as the Artis SE verifies each pedal's orientation during power-up. If you're pressing a pedal, you might cause it to work in reverse.

See Switch Pedal Problems on page 12-5 if you are having trouble with your switch pedal.

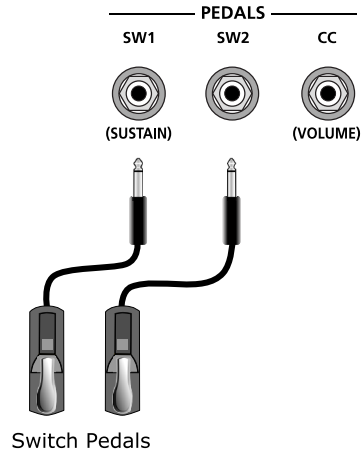

### Connecting a Dual Switch Pedal

You can connect a dual switch pedal with a single stereo plug into the SW1 Pedal and SW2 Pedal jacks. Both SW1 and SW2 can support a dual pedal each allowing up to 4 pedals to be utilized by the Artis SE. These are enumerated as SW1a, SW1b, SW2a and SW2b. The Artis SE will recognize dual pedals that are wired as TS and RS.

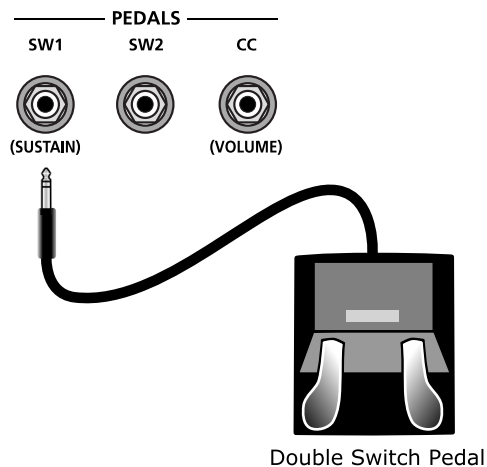

If you're not familiar with traditional piano technique, the sostenuto (center) pedal on a grand piano allows one to hold chords in the bass while continuing to play the melody without the latter notes sustaining. Any keys that are down when you depress the pedal will sustain when you let go of the keys, but new notes played afterward will not be sustained. Releasing the pedal puts things back to normal. Of course it can be programmed to do other functions as well.

The defaults assignment for the Switch Pedals is summarized in the table below.

Pedal	Single Switch Default	Dual Switch Default
<b>SW1a</b>	Sustain (MIDI CC#64)	Sustain (MIDI CC#64)
<b>SW1b</b>		Sostenuto (MIDI CC#66)
<b>SW2a</b>	Sostenuto (MIDI CC#66)	Sostenuto (MIDI CC#66)
<b>SW2b</b>		Soft (MIDI CC#67)

## Connecting a Half Damper Pedal

Half Damper pedals where the wiper is connected to the tip (such as the Kurzweil KP-1H) can be connected to the SW1 and SW2 inputs on the rear panel. Some pedals have the wiper connected to the ring, and these pedals will require an adapter to work with the Artis SE. Half damper pedals can be used to control external software and sound modules via MIDI, enabling finer control of sustain than a standard switch pedal.

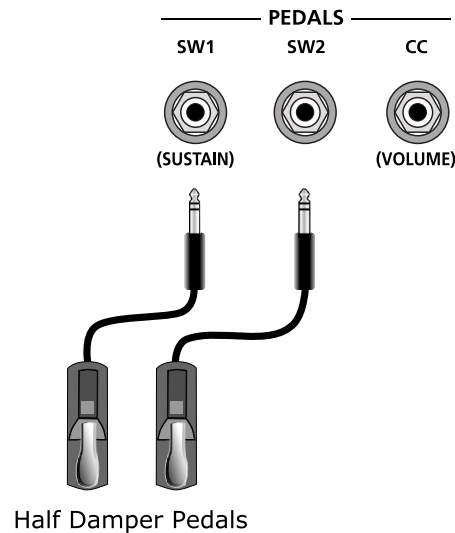

## Connecting a Continuous Control Pedal

A continuous control pedal can be very useful for controlling volume, wah, or other effects by foot.

The Kurzweil CC-1 continuous control pedal will work best with the Artis SE, but it is also possible to use third-party continuous control pedals designed for synthesizers.



**NOTE : Using a third-party continuous control pedal / volume pedal may or may not be satisfactory depending on how it is constructed.**

See Continuous Control and Half-Damper Pedal Problems on page 12-5 if you are having trouble with your continuous control pedal.

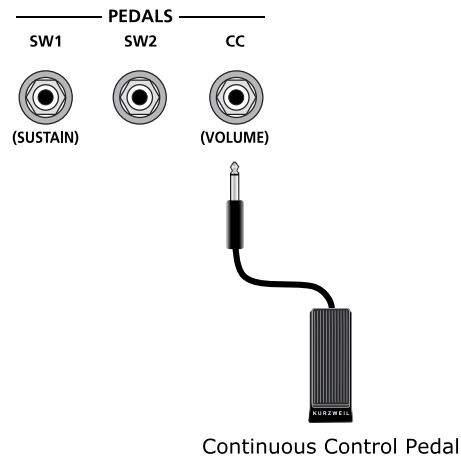



## Connecting MIDI

In addition to being a performance-suited musical instrument, the Artis SE is a powerful, but easy to use MIDI controller. For descriptions of how to customize the Artis SE as a MIDI controller, and how to use its MIDI controller capabilities to their fullest potential, see Multi Mode on page 7-1.

### Basic MIDI Hookup

To use the Artis SE as a MIDI controller for another sound module, use a MIDI cable to connect the MIDI port marked “Out” to the MIDI input port of the module that you want to control.

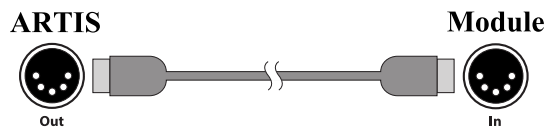

To control the Artis SE using another MIDI controller, use a MIDI cable to connect the MIDI port marked “In” to the MIDI output port of the controller that you will be using.

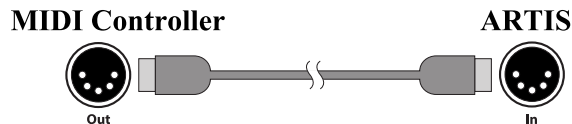

### Connecting More Sound Modules

In order to connect multiple sound modules to be controlled by a single MIDI controller, the Artis SE must either be :

- (1) Used as the controller.
- (2) Or the last module in the MIDI daisy chain.

The reason is because the Artis SE does not include a Thru MIDI port; however, this simply means that the Artis SE must be at the start or at the end of the MIDI daisy chain.

Using the Artis SE as the controller, connect the MIDI Out port to the MIDI In port of the first module, and then connect that module’s MIDI Thru port to the input of the next module, and so on, until the last module is connected.

The MIDI chain should end in the MIDI In port of the last module.

# Getting Started

## Connecting MIDI

### Scenario 1: Artis SE as the MIDI controller

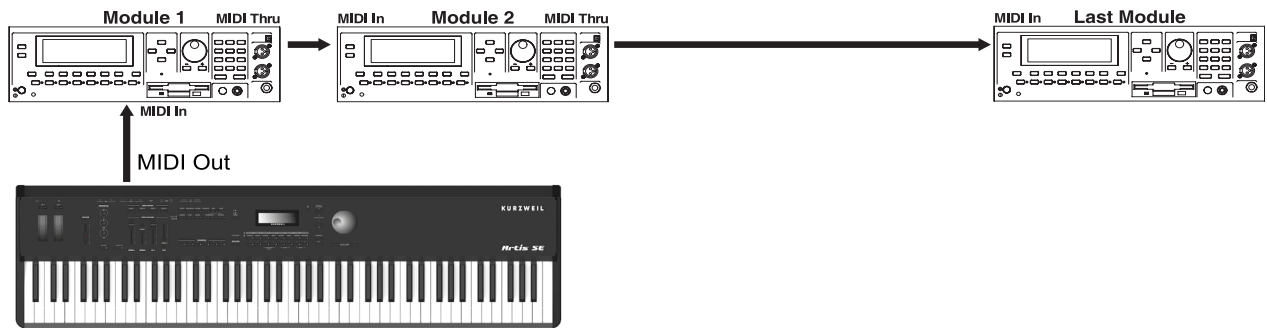

### Scenario 2: Artis SE as the last module in the MIDI chain

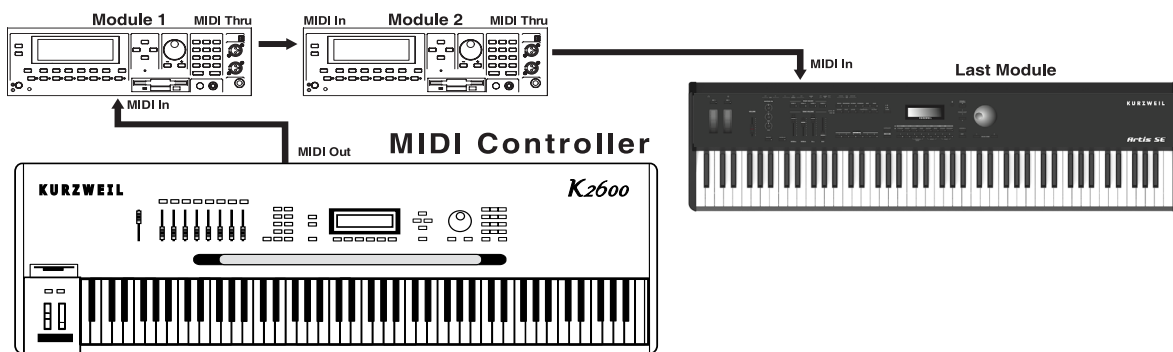

## Connecting to a Computer Sequencer

To connect the Artis SE to a computer/tablet, simply connect Artis SE using the provided or compatible cable.

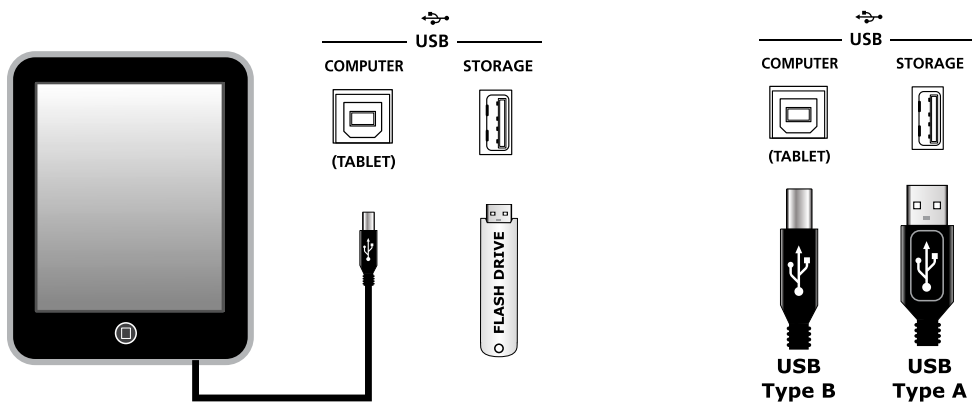

If you wish to use your own cable, make sure that it is a Type-A-to-Type-B USB cable (the USB computer port of the Artis SE being Type B). By default, the Artis SE will act as a MIDI controller (rather than a hard drive) when connected to a computer.

## Selecting Programs and Multis

The Artis SE supports two types of sounds. The first type is a Program, and these are normally a single instrument, such as a piano, or an organ. A Program is similar to a “preset” or “patch” on other synthesizers. The Artis SE has 256 factory Programs, and the space for a further 256 user Programs. Both factory and user Programs are arranged into 16 categories of 16 sounds each.

The other type of sound is the more complex Multi. A Multi is a combination of Programs arranged as layers and splits across the keyboard. They are similar to setups, from the Kurzweil PC series, SP series and K2 series, and are similar to Combis or Multis from other synthesizers. The Artis SE has 128 factory Multis and space for a further 256 user Multis. Similar to Programs, user Multis are arranged into 16 categories of 8 sounds each.

The Artis SE has been designed so that it is quick and easy to select Programs and Multis from the front panel.

Use the following guide to audition the factory sounds on the Artis SE. Program and Multi selection are covered in more detail later in the manual.

The Artis SE always starts in Multi Mode. If you wish to play a Program, simply press the Program Button. The Program Button will light up to show that Program Mode is selected. To return to Multi Mode, from a different mode, simply press the Multi button. If the User button is illuminated, then you are in the User Bank. Press the User Button to return to the Factory Bank, and the LED will go out. In the Factory Bank, press one of the Category Buttons to change Category, and that Category Button will light up. Once you are in your desired Category, press one of the Program/Multi buttons to select the Program/Multi you want.

To select another Program or Multi within the same Category, just press a Program/Multi Button, or use the Alpha Wheel, or + and - Buttons.

To select a Program or Multi in another Category but not in the other Bank (Factory/User), press the desired Category Button, followed by the desired Program/Multi Button. The Alpha Wheel and + and - Buttons will select the next Category once you get to the end of the current Category. Pressing the Category Button will select the Default Program for that Category. The Default Category Program can be set by the user for each Category. By default the Artis SE has the Default Program for each Category set to the first Program of each Category. To change the Default Category Program, see page 6-5.

The Sliders, Wheels, Pedals and Buttons can control each of the factory Programs and Multis, to produce variations to the sound. Don't forget to try these out as you explore the factory sounds on the Artis SE.

# Chapter 3

## Features of the Artis SE

This chapter will help familiarize you with the features of the Artis SE. Many of these features have both general functions and mode-specific functions. For more in-depth descriptions of these features, refer to the chapters on the individual modes.

### Powering Up Defaults

In general, the Artis SE will always remember the last selection made by the user. However, powering up the Artis SE resets some of these settings back to their power-on defaults.

#### Parameters Reset To Defaults At Power-On

- Transpose set to 0 semitones.
- MIDI Channel set to 1.
- At startup Multi Mode is set to the Favorite (or category default) Multi of the Piano1 category.
- Entering Program Mode the selected Program is set to the Category Default Program of the factory Piano1 category.

#### Parameters Remembered After Power-On

- User Programs.
- User Multis.
- Favorites.
- Default Program per Category.
- Default Multi per Category.
- EQ On/Off state.
- Global Mode parameters Velocity Map, View, Destination & Pedal overrides, and AutoPowerOff parameters

## Features of the Artis SE

### The Front Panel

# The Front Panel

All the controls for Artis SE, both musical and navigational, are on its front panel

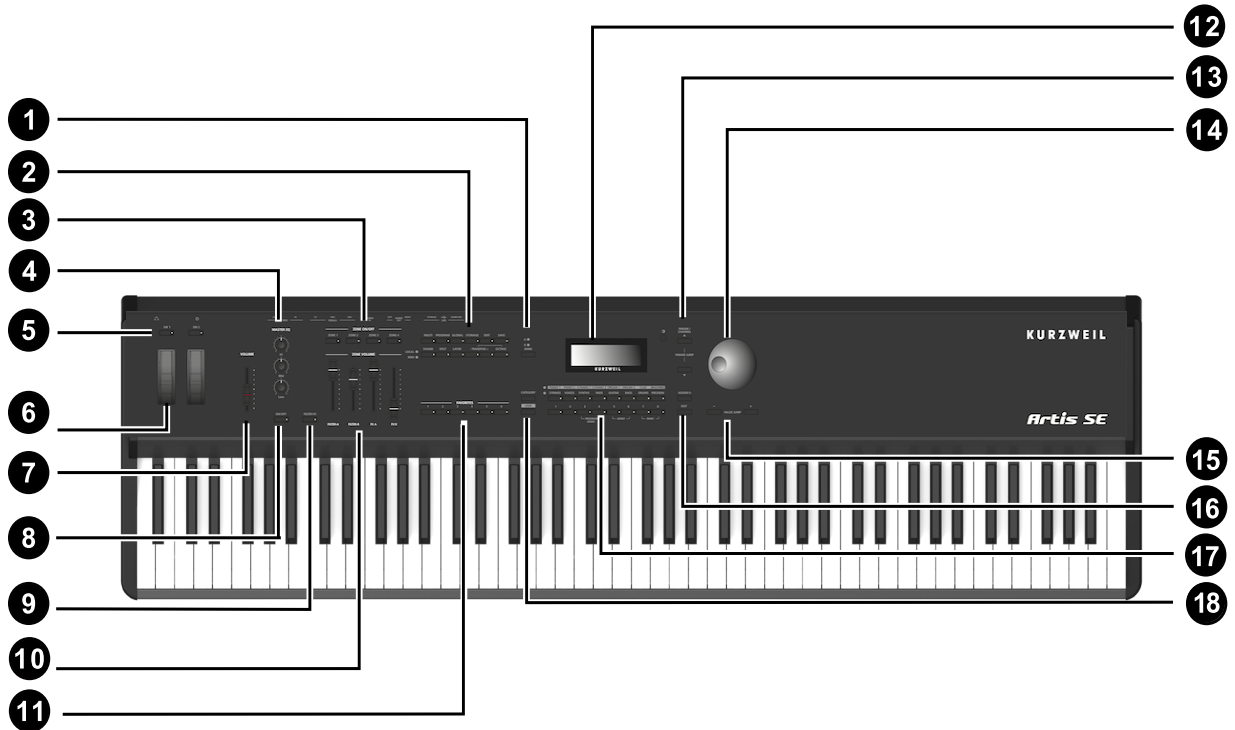

**1** BANK Button

**2** Mode and Function Buttons

**3** ZONE Mute Buttons

**4** MASTER EQ Controls

**5** Programmable Switches

**6** Pitch and Modulation Wheels

**7** VOLUME slider

**8** EQ ON/OFF switch

**9** FILTER-FX switch

**10** ZONE VOLUME Sliders

**11** FAVORITES buttons

**12** Display and display contrast knob

**13** Parameter/Channel buttons

**14** Alpha Wheel

**15** Plus/Minus select buttons

**16** ASSIGN and EXIT buttons

**17** Category Select and Multi/Program select buttons

**18** CATEGORY and USER switches

## Real Time Controls

### Pitch Wheel

The Pitch Wheel is the left most of the two wheels. It is spring-loaded, such that its center position is restored when it is not being used. That is because the Pitch Wheel is used for pitch-bending notes—its “off” position is in the center. Pushing the Pitch Wheel up bends the pitches of all notes up. Pulling the Pitch Wheel down bends the pitches of all notes down.

For some Programs the Pitch Wheel will not bend notes that are held by the sustain pedal. This is how many Guitar and Bass Programs are configured, allowing played notes to be bent over sustained notes. For User Multis, you can program the bend amount for the Pitch Wheel using the Bend Range parameters described *on page 8-10*

### Modulation Wheel

The Modulation Wheel is the right most of the two wheels. Unlike the Pitch Wheel, the Modulation Wheel is not spring loaded, and can be set to and left in any position between fully up and fully down. Typically, the Modulation Wheel is assigned to a parameter that alters some aspect of the sound (e.g., vibrato, filter depth) when changed.

When a KB3 Program is in use, the Modulation Wheel is assigned to control distortion.

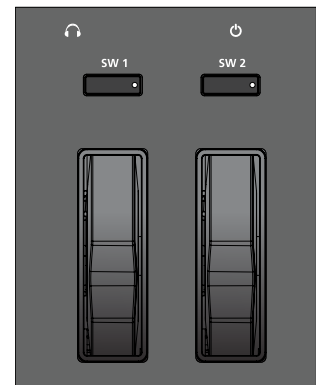

### Programmable Switches (SW1 and SW2)

In Program Mode, the two Switch buttons may be pre-assigned to change the sound in different ways, for example enabling layers or effects.

In Multi Edit Mode, you can assign the Switch buttons to control Program and effects parameters, or send MIDI CC messages to external equipment.

The SW1 and SW2 button LEDs illuminate red when either switch is active.

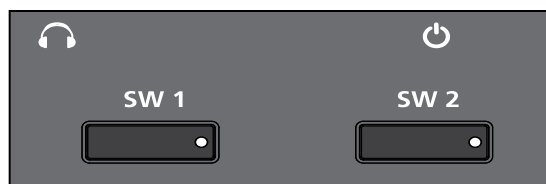

## Features of the Artis SE

---

### Audio Level Controls

## Foot Switches and Controllers

The Artis SE has sophisticated Pedal controller options allowing up to 4 Switch Pedals or up to 2 Half Damper Pedals as well as a Continuous Controller Pedal to be connected. By default the Switch Pedals control SW1a - Sustain, SW1b - Sostenuto, SW2a - Sostenuto and SW2b - Soft. The CC Pedal controls expression by default.

Each Zone in a factory Multi may have different pedal assignments, and pedals are all independently assignable within each Zone of a user Multi.

## Audio Level Controls

### Volume Slider

This controls the output level of the Headphone and Audio Out jacks on the rear panel.

### Audio In

On the back panel of the Artis SE you will find a 1/8" sized stereo audio jack labelled AUDIO IN.

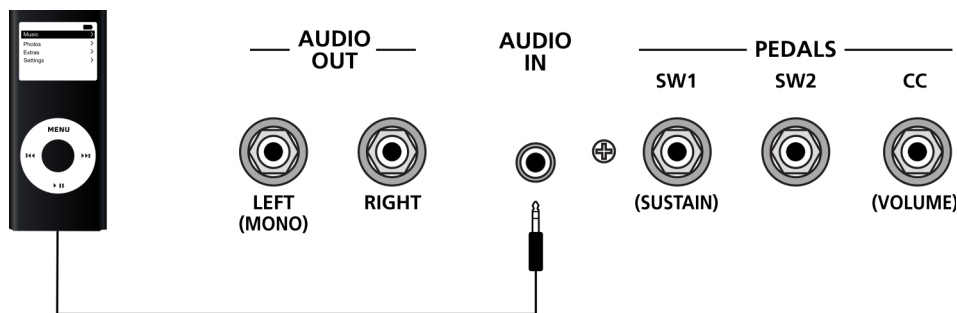

You can plug your MP3 player into the Artis SE and play along with the recorded music. There is no volume control for the Audio Input on the Artis SE itself, so you should control the mix volume of the Audio Input from the MP3 player itself.

### Master EQ

The Master EQ allows you to have realtime control over the frequency response of all audio generated in either Program or Multi Modes. When the Master EQ **On/Off** button is “On”, the rotary knobs can change the high, middle & low frequencies of the audio.

If the LED on the Master EQ On/Off button is lit, this indicates that the Master EQ section is now “on”.

The HI & LOW EQ's are shelving type filters, and the MID is a bell curve type filter centered around approximately 1.4 kHz.

	Frequency	Gain
<b>HI</b>	~6.6 kHz	-24dB to +15dB
<b>MID</b>	~1.4 kHz	-24dB to +15dB
<b>LOW</b>	98 Hz	-24dB to +15dB

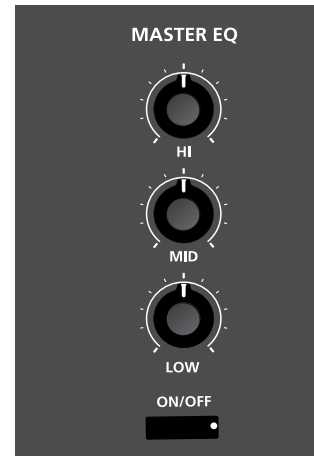

When the Master EQ is on, the audio signal flows as per the diagram above. When it is off, the signal flows as per the diagram below.



## Sliders and Filter-FX button

The four sliders on the left of the front panel are assigned to control different sound parameters and effects for each Multi or Program.

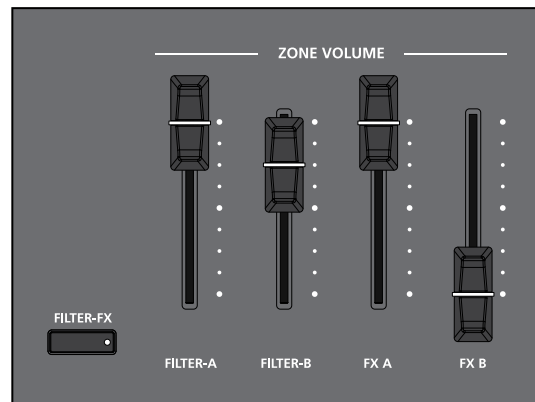



## Features of the Artis SE

### Mode Buttons

In Multi Mode the **FILTER-FX** switch functions as a “shift” button, changing the slider functions when activated. When the **FILTER-FX** switch is disabled the sliders control the volume for each Zone. When the **FILTER-FX** switch is enabled, the sliders control filters, FX, and other parameters. The assignment of each slider can be changed in Multi Edit mode. The sliders can also send MIDI continuous controller values to a computer or external MIDI equipment.

In Program Mode the **FILTER-FX** switch is always active. In most Programs the Sliders labeled Filter-A and Filter-B are assigned to control a filter or EQ parameter in order to control brightness. Slider FX-D controls reverb amount, while Slider FX-C usually controls a second effect such as delay/echo amount.

If you select a KB3 Program, the four sliders act like tone wheel organ drawbars. For KB3 Programs, the sliders operate in a similar way to a classic tone wheel organ, i.e. pulling the slider towards you increases the drawbar amount.

For standard Programs the sliders have the minimum value when they are towards the player and maximum value when they are pushed away from the player.

## ZONE ON/OFF Buttons

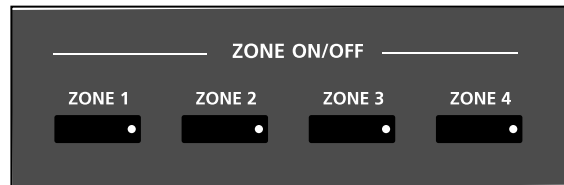

Zones are the independent regions of the keyboard that make up a Multi, for additional information see About Zones on page 7-4.

Pressing a **Zone** button will mute or unmute the Zone. An active/unmuted Zone button has a lit green LED. The LED of an inactive/muted Zone button is not lit.

## Mode Buttons

The Mode buttons are located on the left side of the Artis SE front panel.

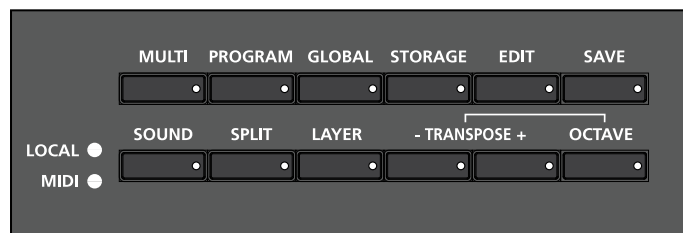

## Multi Button

This button's LED is illuminated when you are in Multi Mode, which is the default Mode. The Artis SE always boots up in this mode.

From any other mode, pressing the **Multi** button enters Multi Mode (described in Multi Mode on page 5-1 and, in further detail, in Multi Mode on page 7-1). In Multi Mode, you can select different configurations of Programs, controller assignments, and MIDI channel assignments.

## Program Button

Pressing the **Program** button enters Program Mode (described in *Program Mode on page 5-2*). In Program Mode, you can select and play different sounds (or "Programs"). This button's LED is illuminated when you are in Program Mode.

## Global Button

Pressing the **Global** button enters Global Mode (described in Global Mode on page 5-1 and, in further detail, in Global Mode on page 9-1). In Global Mode, you can edit parameters that control the overall behavior of the Artis SE. These parameters include tuning, transposition and velocity. Additionally, you can perform a Hard or Soft Reset. This button's LED is illuminated when you are in Global Mode.



**CAUTION: Performing a Hard Reset will erase ALL User Program and User Multis, and will reset Global settings to a factory state.**

## Storage Button

Pressing the **Storage** button enters Storage Mode, allowing data to be loaded into or saved from, the Artis SE. Choices include the storage device connection (USB for flash drives, PC for computers or tablets).

## Edit Button (Multi Edit Mode)

When in Multi Mode, the **Edit** button will initiate Multi Edit mode. From here, you can navigate through the editable parameters of a multi and make specific changes. When you change a parameter, the **Save** button will light. You can then continue to select other parameters (using Navigation controls), or hit the **Exit** button to abandon changes, or hit the **Save** button to save your changes as a User Multi. Refer to *Multi Edit Mode on page 8-1* for more information.

## Save Button

The **Save** button is located on the left side of the LCD screen.

In Program Mode, pressing the **Save** button saves the current position of the sliders, switches and wheels as a User Program. (See *Saving User Programs on page 6-11*)

In Multi Mode, pressing the **Save** button saves a copy of the current Multi. The copy is saved with the states of the Multi **Zone Mute** buttons but does not include the current state of the physical controllers (i.e. moved Sliders, Mod Wheel etc.). Other controller states can be edited in Multi Edit Mode. (See *Saving User Multis on page 8-16*.)

The **Save** button's LED is illuminated once you have made changes to the current Program or Multi to indicate that the Program or Multi has changed.

## Function Buttons

### Sound

The **Sound** button controls the destination of MIDI notes produced by playing the Artis SE keyboard. Pressing the **Sound** Button will step through the options. The LOCAL and MIDI LEDs will indicate the status, where a lit LED indicates that MIDI messages are being sent to that destination. The available options are LOCAL, MIDI, or LOCAL and MIDI.

When LOCAL and MIDI are selected, MIDI notes will be sent to the local Artis SE sound engine, as well as the MIDI Out and USB Computer ports. When only LOCAL is selected, MIDI notes will only be sent to the local Artis SE sound engine. When only MIDI is selected, MIDI notes will only be sent to the MIDI Out and USB Computer ports.

### Split

Pressing the **Split** Button while in either Program or Multi Mode performs the Split Function, creating a new Zone using the lower range of keys. This allows you to split Programs and Multis such that keys in one region of the keyboard produce different sounds than another region.

Hitting **Split** in Program Mode automatically puts the Artis SE into Multi Mode. From there, the split program can be saved as a User Multi.

In Multi Mode, if all four zones are already employed, a Split cannot be performed, and the display will read "No more zones."

## Layer

Pressing the **Layer** Button while in either Program or Multi Mode performs the Layer Function, creating a new zone using the entire keyboard range. This allows you to layer Programs and Multis such that more than one sound can be produced by striking a single key.

Hitting **Layer** in Program Mode automatically puts the Artis SE into Multi Mode. From there, the layered program can be saved as a User Multi.

In Multi Mode, if all four zones are already employed, a Layer cannot be performed, and the display will read “No more zones.”

## Transpose -/+ and Octave

The **Transpose –** and **+** and **Octave** buttons are located at the left of the Artis SE display, just below the Mode buttons

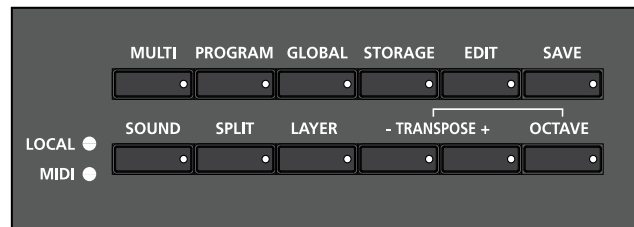

The **Transpose** buttons can be used to change the tuning of notes played on the Artis SE keyboard in semitones (ST), also known as half steps. This is a convenient way to change the key of a song without learning to play it in a different key. The **Transpose** buttons also transpose MIDI notes sent to the USB and MIDI out ports.

Press the Transpose – or + buttons to transpose the Artis SE keyboard down or up by one semitone. The top line of the display shows the current transposition value. To transpose up and down by octave intervals (12 ST), press the Octave button, then select Transpose + or Transpose – .

The maximum transposition value possible is  $\pm 36$  semitones.

The LEDs of the **Transpose** buttons indicate whether the current Program is transposed up (**Transpose +** LED is lit) or transposed down (**Transpose –** LED is lit). When there is no transposition, neither **Transpose** button is lit. Pressing both **Transpose –** and + simultaneously will reset the transposition to 0.

## Favorites

The six **Favorites** buttons allow Programs and Multis to be saved and quickly re-selected. Pressing a **Favorite** button will load the favorite Program or Multi stored in that location.

To save the current Program or Multi as a Favorite, hold down any of the **Favorite** buttons for 3 seconds. When the Favorite has been successfully saved, you will be notified by a message temporarily displayed on the LCD screen.

## Category and sound selection

The Category Select section allows you to quickly and easily get access to sounds in either Program or Multi Modes. You select the Category of sound you want, then use the Program / Multi buttons to select any of the sounds in that Category.

### CATEGORY button

The Artis SE makes it easy to select sounds by instrument type. The 8 Category buttons can access 16 Categories, arranged in two rows. An LED indicates the currently active row, and the **Category** button will let you switch rows. If a Category button is lit, the red LED next to the labels will indicate which Category row you using. Switching Category rows will send you to the first (default) sound in the new Category. Default sounds can be customized; see *Choosing Category Default Programs on page 6-5* and *Choosing Category Default Multis on page 7-4*

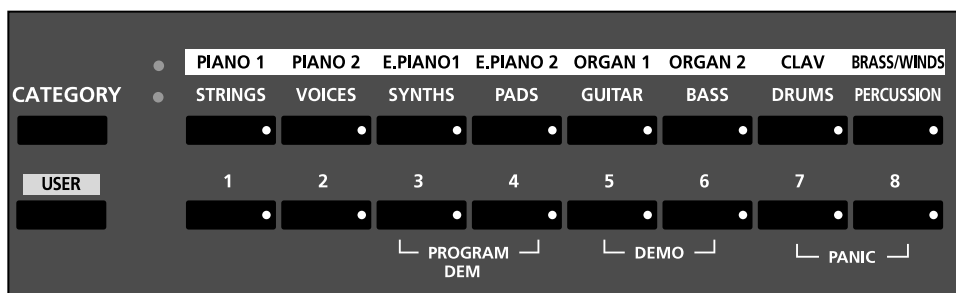

### USER button

The **User** button allows you to select saved User Multis and Programs, arranged in 2 banks, for a total of 16 User Programs or 16 User Multis within each Category.

## A/B Bank button

When a Category has been selected in Program Mode, you can select any of the 16 sounds of that Category by using the **A/B Bank** button. The Program/Multi selection buttons are numbered from 1 to 8; selecting Bank B will give you access to the next 8 Programs in the current Category. In Multi Mode, each factory Category has only eight selections, so the **A/B Bank** button has no effect unless you have saved User Multis.

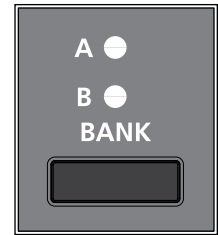

## Navigation

The navigation section of the Artis SE front panel includes the LCD display, (-) and (+) **Value** buttons, **Param / Channel** ▲ and ▼ buttons, and the Alpha Wheel.

### The LCD Display

The Display has 2 rows of 20 characters each. The top row shows the current context (Mode, Transposition, Channel, or other). The lower row shows the current Program/Multi ID and name, or a parameter available for editing. Text in the lower row may scroll to permit more characters to be read.



You can adjust the display contrast by turning a small potentiometer knob located, above the Alpha Wheel.

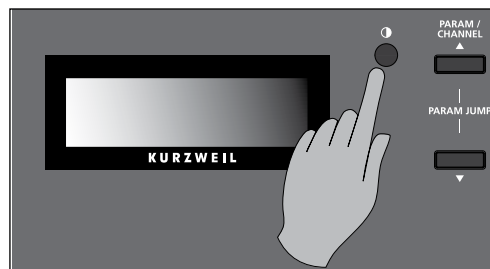

In Multi mode the top line of the display shows the current Mode and MIDI transposition, and the lower line displays the current Multi number and name.

In Multi Edit Mode, the top line of the display shows the current mode, Zone number, the current parameter number and the total number of available parameters.

### Navigation

In Global Mode, the top line of the display shows the current mode, the current parameter and the total number available. The bottom line shows the selected parameter name.

## (-) and (+) Value Buttons

Use the (-) and (+) buttons to scroll through the list of values for the currently selected parameter. Pressing both (-) and (+) buttons simultaneously is referred to as the **Value Jump** double button press. Depending on the selected parameter, Value Jump can select the next Category default Program/Multi, jump to commonly used values, and reset parameters to default values. For more information, see *Value Jump on page 3-13*.

## Param / Channel Buttons

In Program Mode, pressing the **Param/Channel ▲** button will increase the MIDI transmit channel by one. Pressing the **Param/Channel ▼** button will reduce the MIDI transmit channel by one.

When the highest or lowest MIDI transmit channel is reached, the list will wrap back to the last or first MIDI transmit channel respectively. The top line of the display shows the current MIDI transmit channel.

In the other Modes—Multi Edit & Global—pressing the **Param/Channel ▲** and **▼** buttons will scroll through the parameter list for the current Mode.



**NOTE : The Param / Channel buttons are not used in Multi Mode.**

## Alpha Wheel

In Multi and Program Modes you can use the Alpha Wheel to scroll through the list of available Programs/Multis. In Multi Edit Mode you can change values for the currently selected parameter—turning the Alpha Wheel counter-clockwise will select the previous value and turning the Alpha Wheel clockwise will select the next value.

When saving a new User Multi or Program, the Alpha Wheel allows you to scroll through alphanumeric characters to enter a new name. You can turn the Alpha Wheel slowly to change the value by one increment or turn it quickly to jump several increments.

## ASSIGN and EXIT Buttons

The **Exit** button can be used to navigate out of Multi Edit Mode, Save dialogs, the Split/Layer dialogs, Global Mode and Storage Mode, without saving changes.

Pressing and holding the **Assign** button when in the Split function allows you to set the keyboard split location by striking the desired key. In Multi Edit Mode, pressing and holding the **Assign** button allows you to select a Zone by pressing a **Zone On/Off** button. In Multi Edit Mode, pressing and holding the **Assign** button allows you to set the HiKey or LoKey parameter (when selected) for the current Zone by striking a key on the Artis SE keyboard. In Multi Edit Mode, pressing and holding the **Assign** button allows you to quickly select the Destination parameter for a controller of the current Zone by moving the desired controller.

## Double Button Presses

Several pairs of the buttons on the Artis SE have timesaving secondary functions when pressed simultaneously—think of them as keyboard shortcuts. For convenience of reference, descriptions of all of the double-button press functions appear below.

### Value Jump

In Program Mode, the Value Jump double button press selects the first Program of each Category, as well as the Category Default Program of each Category (if a Category Default Program has been set).

For more information on choosing a new Category Default Program, see *Choosing Category Default Programs on page 6-5*.

In Multi Mode, the Value Jump double button press selects the first Multi of each Category, as well as the Category Default Multi of each Category (if a Category Default Multi has been set).

In Multi Edit Mode, pressing the Value Jump double button press resets the current parameter to its default value, or jumps between multiple useful values.

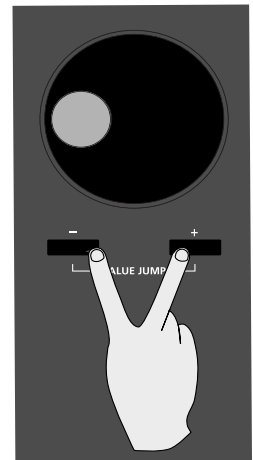

### Parameter Jump

In Multi Edit Mode and Global Mode, pressing both the Param/Channel ▲ and ▼ buttons simultaneously will jump to commonly used parameters or to the first of a group of similar parameters.

In Program Mode, pressing the **Parameter Jump** double button press allows you to change the current MIDI channel by using the numbered Program/Multi Select buttons.

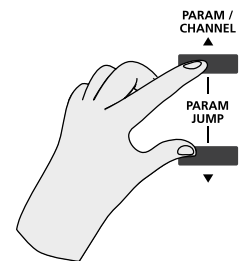

### Reset Transposition

Pressing both **Transpose +** and **Transpose –** simultaneously will restore the current Program or Multi to having no transposition.



## Features of the Artis SE

---

### Double Button Presses

## Program Demo

In Program Mode only, pressing the **3 & 4** Program/Multi buttons performs the Program Demo Function. The Program Demo Function plays the Demo Song for the currently selected Program. Press the **Exit** button to exit the Program Demo at any time.

If you press these buttons from any other Mode, the display will give you a message indicating you are not in Program Mode.

## Demo

Pressing the **5 & 6** Program/Multi buttons performs the Demo Function (described in further detail in *Program and Song Demo Functions on page 5-3*). With the Demo Function selected, you can hear a demonstration song that showcases many of the features of Artis SE.

## Panic

Pressing the **7 & 8** Program/Multi buttons simultaneously deactivates all sounding notes and control messages and sends an “all notes off” message and an “all controllers off” message on all 16 MIDI channels.

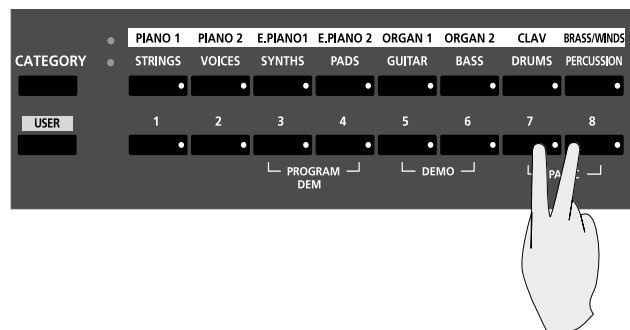

## Assign

Pressing a key, switch, or moving a controller while holding down the **Assign** assign performs “Intuitive Entry.”

### Assign + Zone (1–4) Button

In Multi Edit Mode, holding the **Assign** button and pressing a Multi Zone Mute button will jump to selecting that Zone. The currently selected Zone number can be seen on the top line of the page.

**Assign + Controller**

In Multi Edit Mode, holding the **Assign** button and moving a controller (a Slider, Switch button, Mod Wheel or Pedal) will jump to selecting the destination parameter of that controller in the current Zone. This allows you to quickly assign a controller to a destination.

In Multi Edit Mode, holding the **Assign** button and moving the Pitch Wheel up or down will jump to selecting the Bend Range Up or Bend Range Down parameters of the current Zone.

**Assign + Keyboard key**

In Split Mode with the Split Key parameter selected, hold the **Assign** button and strike a key to select the Split Key.

In Multi Edit Mode with the Low Key or High Key parameter selected, hold the **Assign** button and strike a key to select the Low Key or High Key.

# Chapter 4

## Terminology

This chapter provides definitions and descriptions for all of the Artis SE-specific terms used in this manual. Some of the terms are also used by other manufacturers.

Since there are no standard definitions for some of these terms, they are described here to avoid confusion. All of these terms appear with the first letter capitalized as proper nouns in this manual to make it easy to distinguish between the generic term and the Artis SE specific term.

In addition to the terms below, and to avoid confusion, any Artis SE specific feature, connector or control will have the first letter capitalized to distinguish it from the generic term. Physical button labels will be shown in **bold** type.

---

<b>Program</b>
----------------

A Program is an instrument sound that plays on a MIDI channel. The sound of each Program can be modified by parameters that are assigned to the controllers (Sliders, Switch buttons, Mod Wheel, and Pedals).

See *Program Mode on page 6-1* for more information on Programs.

---

<b>Multi</b>
--------------

A Multi allows up to 4 instrument sounds (Programs) to be played from the keyboard at once. A Multi has 4 Zones, each with its own keyboard range, Program, MIDI channel, and controller assignments.

See *Multi Mode on page 7-1* for more information on Multis.

---

## Terminology

---

<b>KB3</b>	Kurzweil's organ modeling simulation of classic tone wheel organs with rotary speaker emulation
<b>Zone</b>	<p>A keyboard region of a Multi that has its own Program, MIDI channel, and controller assignments.</p> <p>See About Zones on page 7-4 for more information on Zones.</p>
<b>Split</b>	<p>A Split is a Multi containing at least two Zones that have keyboard ranges that don't overlap. This allows different keyboard ranges to play different instrument sounds.</p> <p>See The Split Function on page 7-5 for more information on Splits.</p>
<b>Layer</b>	<p>A Layer is a Multi containing at least two Zones that have overlapping keyboard ranges. This allows a single keyboard range to play multiple instrument sounds.</p> <p>See The Layer Function on page 7-6 for more information on Layers.</p>
<b>MIDI Bank</b>	A group of 128 Programs that can be navigated by MIDI compatible software or hardware.
<b>Mode</b>	<p>An operating status with a unique group of operations.</p> <p>See <i>The Operating Modes on page 5-1</i> for more information on Modes.</p>
<b>Hard Reset</b>	A process that returns Artis SE back to a Factory state. All User Programs & User Multis are erased. All Global Mode parameters are reset back to their default settings as well.

---

---

**Soft Reset**

A process that resets all Global Mode parameters to their default factory settings. User Programs & User Multis are not erased.

---

**Object**

Anything that can be named, saved, deleted, or edited (i.e., a Program or a Multi).

---

**KUF file**

KUF (Kurzweil Unified File) file is a special file that has the objects and operating system combined that is used to update the Artis SE.

---

# Chapter 5

## The Operating Modes

This chapter will help familiarize you with the operating Modes of the Artis SE.

Each of the Modes (Multi, Program, Global, Multi Edit, and Storage) has its own individual chapter. Save is covered in both the Program and Multi Edit chapters. The Functions (Sound, Split, Layer, Transpose and Demos) are described in this chapter in *Functions on page 5-3*.

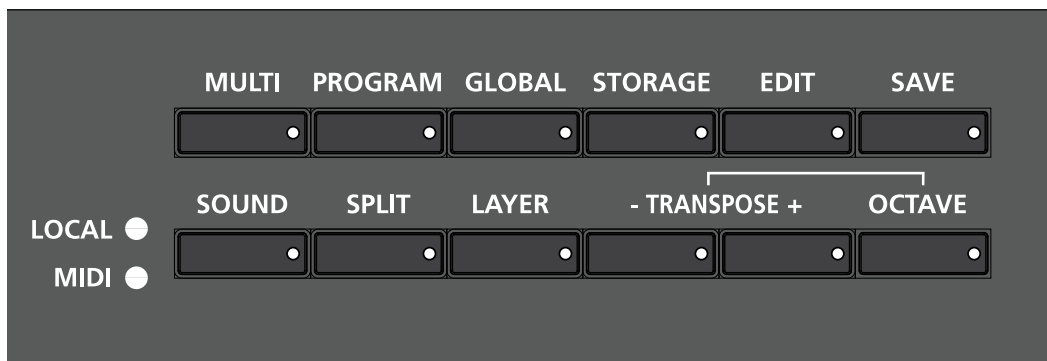

### Multi Mode

Multi Mode is the default Mode for the Artis SE. Multi Mode allows you to select and play Multis.

A Multi allows up to 4 instrument sounds (Programs) to be played from the keyboard at once. A Multi has four Zones, each with its own keyboard range, Program, MIDI channel, and controller assignments. To enter Multi Mode from another Mode, press the **Multi** Mode button.

For more detailed information on Multi Mode, see *Multi Mode on page 7-1*.

## The Operating Modes

---

### Program Mode

## Program Mode

In Program Mode, instrument sounds (Programs) can be selected and played. The sound of each Program can be modified by parameters that are assigned to the controllers (Sliders, Switch buttons, Mod Wheel, and Pedals). Modified Programs can be saved as User Programs by pressing the **Save** button.

To enter Program Mode from another Mode, press the **Program** Mode button.

For more detailed information on Program Mode, see *Program Mode on page 5-2*.

## Global Mode



**CAUTION: THIS MODE CONTAINS CERTAIN OPERATIONS THAT CANNOT BE UNDONE.** Read *Global Mode on page 9-1*

Global Mode allows you to edit global parameters and MIDI settings, load and save User Programs and Multis, or restore factory defaults with a hard or soft reset. To enter Global Mode from another Mode, press the **Global** Mode button. See *Global Mode on page 9-1* for further information.

## Storage Mode

This Mode allows you to save or load files from a computer or other USB-equipped storage device. Begin by pressing the **Storage** Mode button. On the main Storage menu, four options are available: Device (PC or USB), Store, Load (Overwrite) or Load (Fill). Pressing the **Exit** Button while in Storage Mode will return to the previous Mode the instrument was in.

Valid file formats for loading are: **.ART**, **.PC3**, **.P3K**, **.PLE**, **.SPX**, and **.ASE** (Artis SE extension). When a file has been selected to load, pressing the + Button or Assign Button will load the selected file. Pressing the **Exit** Button or - Button will return to the main Storage page. See *Storage Mode on page 10-1* for further detail.

## Multi Edit Mode

Multi Edit Mode allows you to edit pre-existing Multis.

To enter Multi Edit Mode press the **Edit** Button while in Multi Mode. The **Edit** button does apply in Program Mode; however, hitting Split or Layer while in Program mode will also put the Artis SE into Multi Edit mode. See *Multi Edit Mode on page 8-1* for more detail.

---

# Functions

Five Functions, also described in *Function Buttons on page 3-8*, have dedicated buttons.

## The Sound Function

This controls the overall MIDI output of the Artis SE. Hitting **Sound** will step through three possible configurations:

<b>Local</b>	MIDI data is sent only to the Artis SE sound engine. MIDI OUT is disabled.
<b>MIDI</b>	MIDI data is sent only through MIDI OUT. The sounds of the Artis SE are disabled.
<b>Local+MIDI</b>	MIDI data is sent both to the Artis SE sound engine and through the MIDI OUT.

This will override any Zone-specific settings (see *Destination (Dest) on page 8-6* for more info.)

## The Split Function

See *The Split Function on page 6-6 (for Splits in Program Mode)* and *The Split Function on page 7-5 (for Splits in Multi Mode)*.

## The Layer Function

See *The Layer Function on page 5-3 (for Layers in Program Mode)* and *The Layer Function on page 7-6 (for Layers in Multi Mode)*.

## Transpose Functions

The **Transpose** and **Octave** buttons will transpose the entire keyboard. See *Transposition on page 6-5* and *Transposition on page 7-4* for more information.

## Program and Song Demo Functions

Pressing the **3 & 4** Program/Multi buttons simultaneously will play a brief demonstration using the current Program. Pressing the **5 & 6** Program/Multi buttons simultaneously will play built-in Demo Songs designed to demonstrate the capabilities of the Artis.

Song Demos will display a song title and the total number of available Demos; Program Demos will display the Program name. Use the Alpha Wheel, **Value** buttons or the **Param/Channel ▲** and **▼** buttons to select another Song Demo from the list.

The Program/Multi button LEDs blink when using the Demo Function. Press the **Exit** Button to exit either Demo Function.



# Chapter 6

## Program Mode

This chapter will help familiarize you with the features of Program Mode.

Programs are essentially the different sounds of a MIDI instrument—they are preset instrument sounds equivalent to the “patches,” “presets,” or “voices” that you find on other keyboards.

### About Program Mode

To enter Program Mode from another Mode, press the **Program** mode button. While you are in Program Mode, the **Program** button’s LED is illuminated.

When you enter Program Mode after powering on the Artis SE, the Category Default Program in the Piano 1 category will be selected, either Program 1 (factory default) or a Program you pick as a Category Default Program for the Piano 1 category. See *Choosing Category Default Programs* on page 6-5.

If you enter Program Mode from another Mode, the current Program will be the last selected Program on the current MIDI Channel.

### Selecting Programs

The Artis SE features two Program Banks, one of which contains 256 factory Programs, and the other Bank is reserved for up to 256 User Programs. Both the factory and User Banks are split into 16 categories of 16 Programs each.

When you are in Program Mode, there are a few ways to select Programs.

- To select a Program in the current Category, press the relevant Program/Multi button.
- To select a Program in a different Category, press the Category button of choice and then a Program/Multi button to select from the 16 Programs in the Category.
- To select the default Program from a Category, simply press the relevant Category Button.

## Program Mode

---

### Selecting Programs

- Choosing a Program in the user Categories, while in the factory Categories, or choosing a Program in a factory Category while in a user Category, requires pressing the **User** button, followed by a Category button and then a Program/Multi button.
- The Alpha Wheel and the **−** and **+** buttons allow you to advance through the Programs one at a time. When you reach the end of the Category, advancing further will go to the next Category.
- If a Program is assigned to a **Favorite** button, pressing that button will go directly to the assigned Program.

## Program Demo

If you want to quickly hear what a Program sounds like in performance, try the Program Demo Function

In Program Mode only, pressing the **3 & 4** Program/Multi buttons performs the Program Demo Function. The Program Demo Function plays a Demo Song for the currently selected Program.

Press the **Exit** button to exit Program Demo.

If you try to use the Program Demo Function from any other Mode, the display will give you a message indicating you are not in Program Mode.

## The Display

In Program Mode, initially the top line of the display shows the current Mode, Transposition (XPOSE) and MIDI channel. The Program ID number and name are displayed on the second line. If a slider is moved, the second line displays the parameter affected and the value change.



### Pop Up Messages

Some actions, such as moving a slider, cause the display to show pop up messages on the second line indicating the controller assignment. After a short time the display returns to show the current Program.

## Alpha Wheel & – and + Value Buttons

Use the Alpha Wheel, or the – and + buttons below the Alpha Wheel, to change the current Program. Turning the Alpha Wheel counter-clockwise or pressing the – button will select the previous Program and turning the Alpha Wheel clockwise or pressing the + button will select the next Program. When the highest or lowest Program is reached, the list will wrap back to the last or first Program respectively.

When scrolling through the Program list, the list moves through each Category, both factory and User.

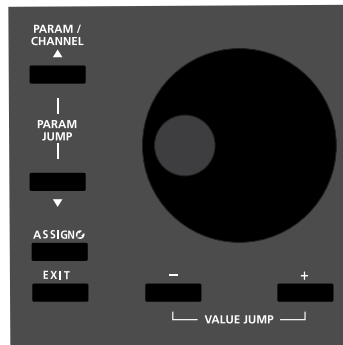

## Value Jump Buttons

In Program Mode, the **Value Jump** double button press selects the first Program of each Category, as well as the Category Default Program of each Category (if a Category Default Program has been set).

For more information on choosing a new Category Default Program for each Category, see Choosing Category Default Programs on page 6-5.

If the **User** button is selected, **Value Jump** works the same way.

## Program Mode

### Selecting Programs

## Category & Program/Multi Buttons

The Category buttons allow you to select Programs by instrument type simply by pressing a button. You can select one Category button at a time and the current Category button's LED is lit.

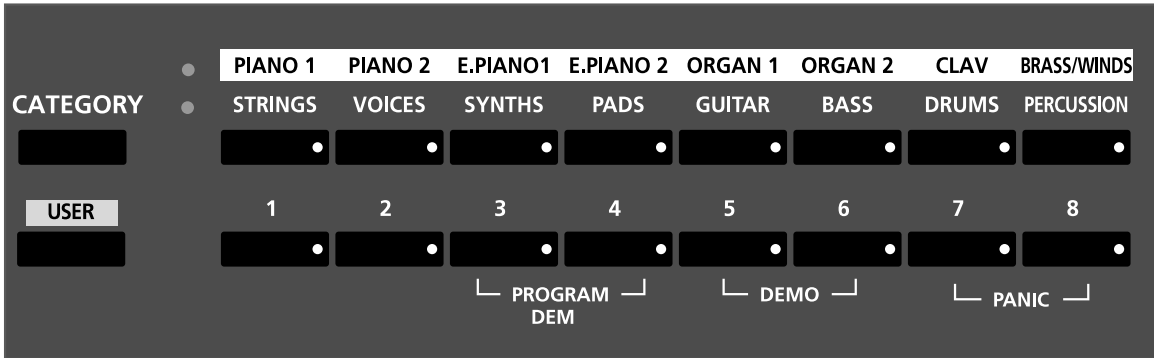

There are 16 categories to choose from, arranged in two rows, as labelled. Use the **Category** button to the left to switch between rows. An LED will light to indicate the selected row.

Each Category contains 16 Programs of a single instrument type arranged in 2 Banks (A and B). First select the Category you want by pressing a Category button, then select one of the 8 Programs in the current Bank by pressing one of the Program/Multi buttons numbered from 1 to 8. Press the **Bank** button to switch between Bank A and B.

You can also press one of the instrument Category buttons, then turn the Alpha Wheel clockwise or press the + button to advance to the next Program in the Category. When you reach the end of a Category, the Artis SE automatically advances to the beginning of the next Category. This will also work in reverse if you turn the Alpha Wheel counter-clockwise or press the - button. In this case when you reach the beginning of a Category, the Artis SE automatically advances to the end of the previous Category. These controls will scroll through all of the categories in the current Bank, and the next Bank will be automatically selected when the end of the current Bank is reached. The 16 User Categories come after the factory ones, but only non-empty programs can be selected this way.

## Choosing Category Default Programs

You can choose a “Category default program” from each Category that will be recalled each time you press that Category’s button. To save a Category default program, first select a Program using any Program select method (Alpha wheel, **–** and **+** buttons, Category buttons, Program/Multi buttons). A Category button for the current Category will have a lit LED. Next, press and hold the currently lit Category button until the display shows the message “default program saved.” The Category default program has now been successfully saved.

You can only save a Program as a Category default for the Category that it belongs to. If you try to save a Category default program to a different Category, you will see a pop up message in the display.

## Choosing Favorites

You can save six Favorite Programs (or Multis) from any Category to the six **Favorite** buttons beneath the display. Once saved, these favorite Programs can be recalled from any Mode with a single button press. To save the currently selected Program or Multi to a **Favorite** button, press and hold a **Favorite** button until the display shows the message “Saved to fav. button.”

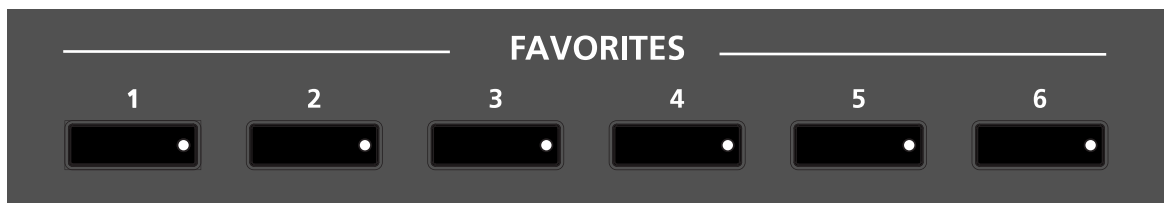

## Transposition

The **Transpose** buttons can be used to change the tuning of notes played on the Artis SE keyboard in semitones (ST), also known as half steps. This is a convenient way to change the key of a song without learning to play it in a different key. The **Transpose** buttons are located to the left of the display. The **Transpose** buttons also transpose MIDI notes sent to the USB and MIDI out ports.

Press the **Transpose –** or **+** buttons to transpose the Artis SE keyboard down or up by one semitone. The top line of the display shows the current transposition value. Pressing both **Transpose –** and **+** simultaneously will reset the transposition to 0. To transpose up and down by octave intervals (12 ST), press the **Octave** button, then use the **Transpose –** and **+** buttons to change the octave.

The maximum transposition value possible is +/-36 semitones.

## Program Mode

---

### Parameter Assignments

The LEDs of the **Transpose** buttons indicate whether the current Program is transposed up (**Transpose+** LED is lit) or transposed down (**Transpose-** LED is lit). When there is no transposition, neither **Transpose** button is lit.

## Parameter Assignments

In Program Mode, each Program has factory set Program and Effect parameters assigned to physical controllers (Sliders, Switch buttons, Mod Wheel, and Pedals). A parameter assignment can modify an instrument sound during a performance to add variation or expression. Moving a controller changes the value of the parameter. Any time you do this, the display shows the Controller name, assigned parameter, and value.

For most programs, the Sliders labeled **Filter-A** and **Filter-B** are assigned to filter or EQ parameters in order to control brightness. The Slider labeled **FX B** is usually assigned to control reverb amount, and the Slider labeled **FX A** is sometimes assigned to control delay amount or another effect. The remaining controls may have different assignments depending on the selected Program.

If you make changes to the current Program using any of the controllers, the **Save** button's LED lights to indicate that a change has been made to that Program. For more information on the **Save** button, see Save User Programs on page 6-11.

## The Split Function

The Split Function allows you to split Programs such that keys in one region of the keyboard produce different sounds than another region.

When you create a Split in Program Mode, you are in fact creating a Multi with two active Zones (see Multi Mode on page 7-1, for more information on Multis). Multis are configurations of four Zones, each of which may have its own Program and controller assignments.

The Split Function is convenient, as you do not need to use Multi Edit Mode to configure Zone key ranges, Programs, and volumes. You can simply hit the **Split** button, and the Artis SE automatically creates a Multi with two active Zones. The Program you were initially using in Program Mode is used in the right hand of the Split, as the Program for Zone 1.

After hitting the **Split** button you can choose a "Split Program" that will be used in the left hand of the Split as the Program for Zone 2.

Once you have saved your Split as a User Multi, you can continue to add Split or Layer Zones to the Multi until you reach the maximum of four active Zones. The Artis SE will display a message if you have already reached the maximum of four active Zones (see Multi Mode on page 7-1, for more information on Multis).

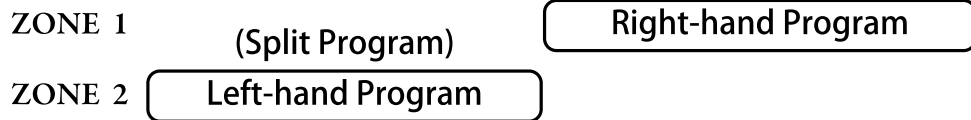
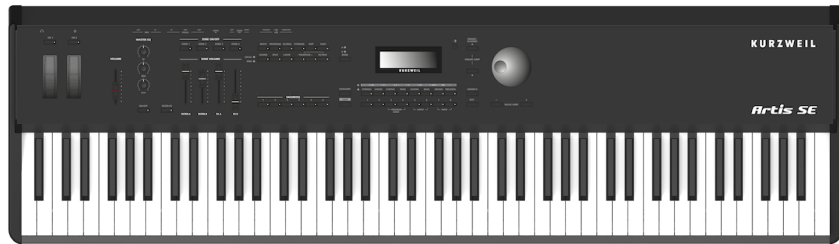

There are four parameters (described below) that determine the behavior of the Split. These can be accessed by using the **Param/Channel** buttons.

### Split Program

Move the Alpha Wheel or use a Category/Program button to select the Split Program. This determines the Program for the left-hand side of the Split keyboard. Initially the last used Split Program will be selected, or, if this is the first time using the Split Function since power-up, the default Split Program (106 Motown Bass) will be selected.

### Split Volume

Press the **Param/Channel ▲** button to select the Split Volume parameter. This determines the balance of the left and right-hand Programs. By default, the Split Volume is set to 0, which results in both Programs having the same volume. When set to a positive number, the volume for the right hand Program is decreased. When set to a negative number, the volume for the left hand Program is decreased. To set the Split Volume, use the Alpha Wheel, or **-** and **+** buttons. Split Volume can be set to any number between -127 and 127. Pressing the **Value Jump** button pair resets the volume to 0.

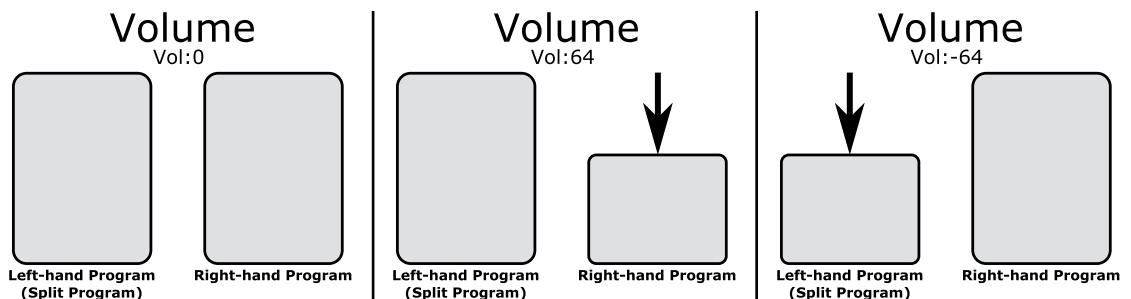

## Program Mode

---

### The Layer Function

#### Split Key

Press the **Param/Channel ▲** button again to select the Split Key parameter. This sets the keyboard key that will be the boundary between the left and right hand Programs on the keyboard. The selected key will be the highest note for the left-hand Split Program. All keys higher than the Split Key will play the right-hand Program. By default, the Split Key is set to B3. The Split Key can be selected holding the Assign  button down and then striking the desired key on the keyboard. The Split Key can also be selected by using the Alpha Wheel or **-** and **+** buttons. Split Key can be set to any key between A0 and C8.

#### Split Transpose

Press the **Param/Channel ▲** button again to select the Split Transpose parameter. This parameter allows you to transpose the left-hand Split Program in octaves so that you can play it in higher or lower octaves. Use the Alpha Wheel or **-** and **+** buttons to set the Transpose value. Transpose can be set to -24, -12, 0, 12, and 24. By default, Split Transposition is set to +12.

## Saving a Split

After setting the Split parameters, the Split can be saved as a Multi so that it can easily be recalled in Multi Mode. Press the **Save** button to the left of the display to begin the saving process.

See Save User Multis (page 7-8) in the Multi Mode Chapter for details on saving. Once you have saved your Split as a Multi, you can continue to add Split or Layer Zones to the Multi until you reach the maximum of four active Zones.

See the Split Function (page 7-5) and the Layer Function (page 7-6) in the Multi Mode Chapter. Also, once you have saved your Split as a Multi, you can edit controller assignments and other Multi parameters in Multi Edit Mode (see Multi Edit Mode on page 8-1 for details).

## The Layer Function

Pressing the **Layer** button while in Program Mode will perform the Layer function. The Layer Function allows you to layer Programs and Multis such that more than one sound can be produced by striking one key.

When you create a Layer in Program Mode, you are in fact creating a Multi with two active Zones (see Multi Mode on page 7-1, for more information on Multis). As previously described, Multis are configurations of four Zones, each of which may have its own Program and controller assignments.



The Layer Function is convenient, as you do not need to use Multi Edit Mode to configure Zone key ranges, Programs, and volumes. You can simply hit the **Layer** button, and the Artis SE automatically creates a Multi with two active Zones. The Program you were using in Program Mode is used as the Program for Zone 1. After this you can choose a “Layer Program” that will be used as the Program for Zone 2.

Once you have saved your Layer as a Multi, you can continue to add Layer or Split Zones in Multi Mode until you reach the maximum of four active Zones. The Artis SE will display a message when you have reached the maximum of four active Zones (see Multi Mode on page 7-1, for more information on Multis)

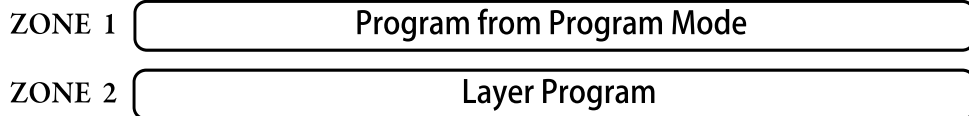
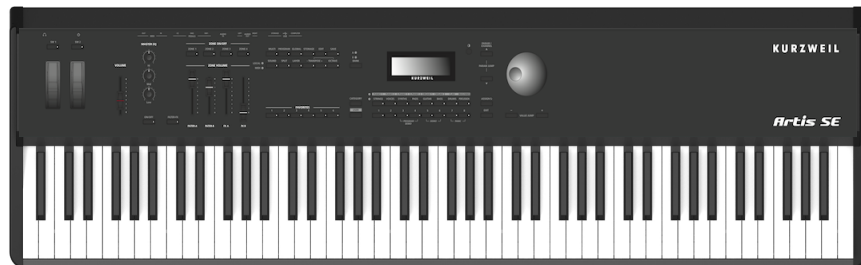

There are three parameters (described below) that determine the behavior of the Layer.

### **Layer Program**

The Layer Program parameter is the default parameter. It determines the “Layer Program” that will be layered on top of the Program you were using in Program Mode. Initially the last used Layer Program will be selected, or, if this is the first time using the Layer Function since power-up, the default Layer Program (224 Add a Pad 2) will be selected. Choose a Layer Program using the Category and Program/Multi buttons, the Alpha Wheel, or the **–** and **+** buttons.

### **Layer Volume**

Press a **Param/Channel** button to select the Layer Volume parameter. This determines the volumes of the Program from Program Mode and the Layer Program. By default, the Layer Volume is set to 0, which results in both Programs having the same volume. When set to a positive number, the volume for the Program from Program Mode is decreased. When set to a negative number, the volume for the Layer Program is decreased. To set the Layer Volume, use the Alpha Wheel or **–** and **+** buttons. Layer Volume can be set to any number between -127 and 127. Pressing the **Value Jump** button pair resets the volume to 0.

## Program Mode

---

### Changing the Transmit MIDI Channel

#### Layer Transpose

Press the **Param/Channel ▲** button again to select the Layer Transpose parameter. This parameter allows you to transpose the Layer Program in octaves so that it sounds octaves higher or lower than the other Program you are layering on top of. Use the Alpha Wheel or **–** and **+** buttons to set the Transpose value. Transpose can be set to -24, -12, 0, 12, and 24. By default, Layer Transpose is set to 0.

### Saving a Layer

After setting the Layer parameters, the Layer can be saved as a Multi so that it can easily be recalled in Multi Mode. Press the **Save** button to the left of the display to begin the saving process. See Save User Multis (page 7-8) in the Multi Mode Chapter for details on saving.

Once you have saved your Layer as a Multi, you can continue to add Split or Layer Zones to the Multi until you reach the maximum of four active Zones. See the Split Function (page 7-5) and The Layer Function (page 7-6) in the Multi Mode Chapter. Also, once you have saved your Layer as a Multi, you can edit controller assignments and other Multi parameters in Multi Edit Mode (see Multi Edit Mode on page 8-1 for details).

## Changing the Transmit MIDI Channel

The current MIDI Transmit channel is shown on the right side of the top line of the display. Press the **Param/Channel ▲** or **▼** buttons to change the MIDI Transmit channel. A different Program can be selected for each MIDI Channel. All channels can be triggered simultaneously from an external MIDI sequencer or computer. The Aux FX Chains of the Program on the currently selected MIDI Channel are used for Programs on all Channels.



Pressing both **Param/Channel ▲** and **▼** at the same time (**Param Jump**) will let you select a MIDI transmit channel (1-8) using the numbered Category buttons.

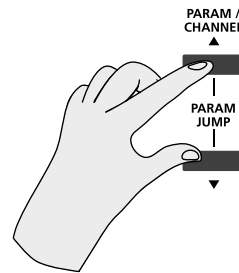

If a MIDI Channel is disabled, the Program name is shown with parenthesis and the message “Channel disabled” on the line above.

MIDI Channels are enabled/disabled in Global Mode, see Channel Enable (ChanEn) on page 9-6.

## Panic

Pressing the 7 and 8 Program/Multi buttons (**Panic**) simultaneously deactivates all sounding notes and resets controller values by sending an “All Notes Off” message and a “Reset All Controllers” message on all 16 MIDI channels.

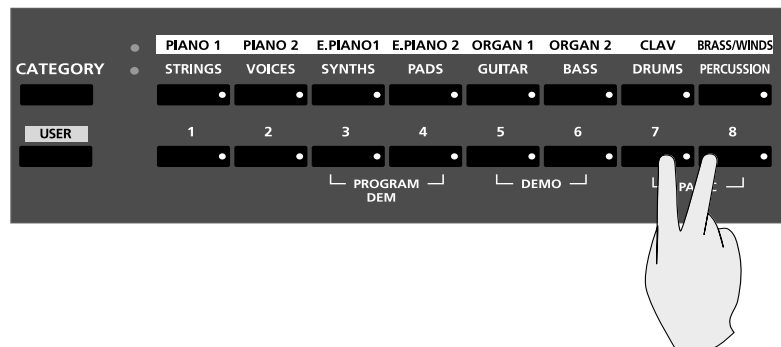

## Saving User Programs

If you make changes to the current Program using any of the controllers, the **Save** button’s LED lights to indicate that a change has been made to that Program.

To save the changes you’ve made, press the **Save** button once. The **Save** button’s LED begins to blink, allowing you to set the ID number and rename the Program. The display shows the first available ID number and the current Program name.

## Program Mode

---

### Saving User Programs

You can save Programs with ID numbers from 257 to 512. When you initially press the **Save** button, the Artis SE always selects the next available unused ID number and displays the current Program name. After specifying the Program ID number and name, press the **Save** button again to complete the saving process.

### Changing ID Numbers

To change the ID number, turn the Alpha Wheel or use the **+** and **-** buttons to select the new ID number. You can also use the Bank, Category and Program/Multi buttons to select an ID number, which is useful for organizing User Programs by Category. To do this, first select a Bank and Category button, then select a Program/Multi button to select an ID within that category.

### Naming a User Program

To rename the new Program press a **Param/Channel** button until you see “Rename Program as:”.



The display shows the current Program name. Use the Alpha Wheel to select characters for the new Program name. Press the **+** or **-** button to move the cursor to the other characters. Program names can total 16 characters in length.

### Locating a saved User Program

Press the **Save** button to complete the saving process, or press the **Exit** button to exit without saving. After successfully saving, the Program will be selected in Program Mode in the User Bank. To find the Program again later, make sure to press the **User** bank button under the **Category** button.

# Chapter 7

## Multi Mode

This chapter will help familiarize you with the features of Multi Mode.

Multis are configurations of four Zones, each of which may have its own Program, controller assignments, and MIDI transmit channel. A Zone can also be configured to control an external sound module or computer software through a MIDI or USB cable.

### About Multi Mode

To enter Multi Mode from another Mode, press the **Multi** Mode button.

While you are in Multi Mode, the **Multi** button's indicator LED is illuminated.

When you enter Multi Mode after powering on the Artis SE, the Category Default Multi in the Piano1 Category will be selected, either Multi 1 (factory default) or a Multi you pick as a Category Default Multi, see Choosing Category Default Multis on page 7-4.

The first 16 factory Multis (IDs 1-16 in the Piano 1 and Piano 2 categories) each have a single active Zone containing piano, electric piano or guitar. When using these Multis you can quickly add additional string, bass and pad layers by using the Zone On/Off buttons to turn on Zones 2-4. These Multis are useful for composition, performance, or as a template for creating simple User Multis. When the **Filter-FX** button is disabled, the 4 sliders can be used to adjust the volume of each Zone. Check out the rest of the 128 factory Multis to find other inspiring Multis and some more complex configurations.

### About Zones

Zones are the independent regions of the keyboard that make up a Multi.

A Multi has four Zones, each one having its own Program, controller assignments, and MIDI transmit channel. Zones can be mutually exclusive regions of the keyboard, or they can overlap. A Zone can also be configured to control an external sound module or computer software through a MIDI or USB cable.

## Multi Mode

### Selecting Multis

---

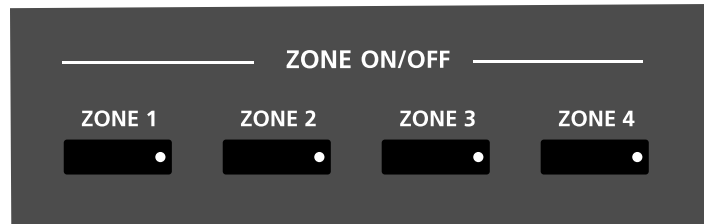

### Muting Zones

Pressing a **Zone On/Off** button will mute or unmute the Zone. An active/unmuted Zone button has a lit LED. The LED of an inactive/muted Zone button is not lit.

## Selecting Multis

When you are in Multi Mode, there are a few ways to select Multis.

- To select any Multi in the current Category, press a Program/Multi button.
- To select a Multi in a different Category, press the Category Button of choice and then the Program/Multi Button to select from the 8 Multis in the Category.
- To select the Category Default Multi, simply press a Category Button.
- To switch between the Factory and User Multis, press the **User** Button, followed by a Category button and then a Program/Multi button. Unlike factory Multis which have 8 Multis per category, User Multis have 16 Multis per category. Two sets of 8 User Multis can be selected for each Category by pressing the **Bank** button.
- The Alpha Wheel and the **+** & **-** buttons allow you to advance **through** the Multis one at a time. When you reach the end of the Category, advancing further will go to the next Category.
- If a Multi is assigned to a **Favorite** Button, pressing that button will go directly to the assigned Multi.

## The Display

In Multi Mode, the top line of the display shows the current Mode and MIDI transposition. The lower line shows the Multi ID number and name.

### Pop Up Messages

Actions such as moving a controller cause the display to show pop up messages. After a short time the display returns to show the current Multi.

## Alpha Wheel and — & + Value Buttons

Use the Alpha Wheel or the Value buttons, to the right of the display below the Alpha Wheel, to change the current Multi. Turning the Alpha Wheel counter-clockwise or pressing the — button will select the previous Multi and turning the Alpha Wheel clockwise or pressing the + button will select the next Multi. When the highest or lowest Multi is reached, the list will wrap back to the last or first Multi respectively.

## Value Jump Buttons

In Multi Mode, the **Value Jump** double button press selects the first Multi of each Category, as well as the Category Default Multi of each Category (if a Category Default Multi has been set). For more information on choosing a new Category Default Multi, see Choosing Category Default Multis on page 7-4. If the **User** button is selected, **Value Jump** works the same way.

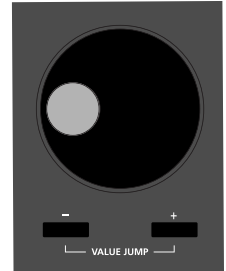

## Category & Program/Multi Buttons

The Category buttons allow you to select Multis from a group of 8 Multis per category. Multis are not categorized by instrument type, so the instruments used in a Multi may not match its category name (category instrument names only apply to selecting Programs in Program Mode). You can select one Category button at a time and the current Category button's LED is lit.

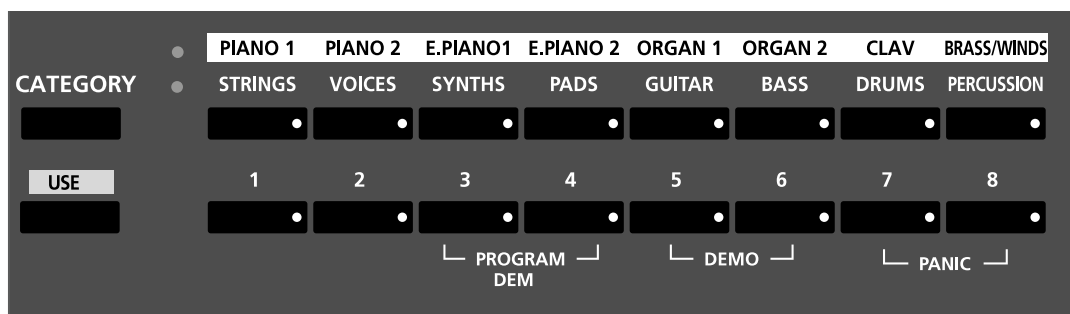

Each Category contains 8 Multis. First select the Category you want, then select one of the 8 Multis by pressing any of the Program/Multi buttons numbered from 1 to 8.

## Choosing Category Default Multis

You can choose a “Category Default Multi” from each Category that will be recalled each time you press that Category’s button. To save a Category Default Multi, first select a Multi using any Multi select method (Alpha wheel, **−** & **+** buttons, Category buttons, Program/Multi buttons). A Category button for the current Category will have a lit LED. Next, press and hold the currently lit Category button until the display shows a message indicating that the Category Default Multi has been saved.

You can save one Category Default Multi per Category button.

## Choosing Favorites

You can save six Favorite Multis (or Programs) from any Category to the six **Favorite** Buttons. Once saved, these Favorite Multis can be recalled from any Mode with a single button press. To save the currently selected Multi to a Favorite Button, press and hold a **Favorite** Button until the display shows the message “Multi saved to fav. button.”

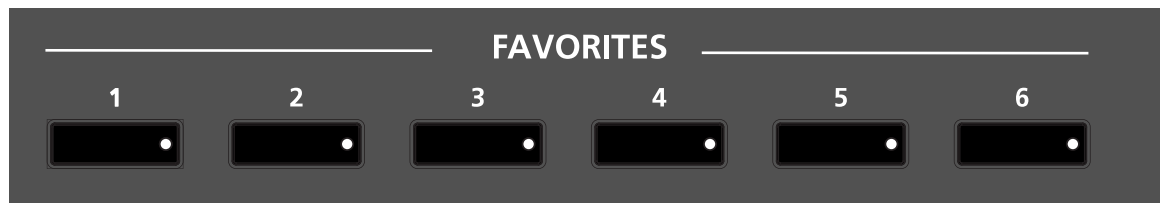

## Transposition

The **Transpose** buttons can be used to change the tuning of notes played on the Artis SE keyboard in semitones (ST), also known as half steps. This is a convenient way to change the key of a song without learning to play it in a different key. The **Transpose** buttons are located to the left of the display. The **Transpose** buttons also transpose MIDI notes sent to the USB and MIDI out ports.

Press the **Transpose −** or **+** buttons to transpose the Artis SE keyboard down or up by one semitone. The top line of the display shows the current transposition value. Pressing both **Transpose −** & **+** simultaneously will reset the transposition to 0. To transpose up and down by octave intervals (12 ST), press the **Octave** button and use **− Transpose +** buttons.

The maximum transposition value possible is  $\pm 36$  semitones.

The LEDs of the **Transpose** buttons indicate whether the current Multi is transposed up (**Transpose +** LED is lit) or transposed down (**Transpose −** LED is lit). When there is no transposition, neither **Transpose** button is lit.





**NOTE :** The transposition created this way is applied to all Programs in the Zones within the Multi. The Zone layout on the keyboard however still remains fixed.

## The Split Function

Pressing the **Split** button while in Multi Mode performs the Split Function. The Split Function allows you to split Multis such that keys in one region of the keyboard produce different sounds than another region.

When you create a Split in a Multi, you are in fact activating a new Zone within the current Multi. If the current Multi already has its maximum of four active Zones and you press the **Split** function button, then a message will appear on the display indicating that you have reached the maximum of four active Zones. Once you have saved your Split, you can continue to add Split or Layer Zones to the Multi until you reach the maximum of four active Zones.

The Split Function is convenient, as you do not need to use Multi Edit Mode to configure Zone key ranges, Programs, and volumes. You can simply press the **Split** button, and the Artis SE automatically activates another Zone in the Multi for you. The previously active Zones are used in the right hand of the Split. After this you can choose a “Split Program” that will be used in the left hand of the Split as the Program for the newly activated Zone.

There are four parameters (described below) that determine the behavior of the Split. Press the **Param/Channel** buttons to the right the display to access each of the Split parameters.

### Split Program

The Split Program parameter determines the Program for the left-hand side of the Split, also known as the “Split Program.”

Initially the last used Split Program will be selected, or, if this is the first time using the Split Function since power-up, the default Split Program (106 Motown Bass) will be selected . Choose a Split Program using the Category and Program/Multi buttons, the Alpha Wheel, or the **-** & **+** buttons.

## Multi Mode

---

### The Layer Function

#### Split Volume

This parameter determines the volumes of the left and right-hand Zones. By default, the Split Volume is set to 0, which results in all Zones having the same volume. When set to a positive number, the volume for the right hand Zone(s) is decreased. When set to a negative number, the volume for the left hand Zone(s) is decreased. To set the Split Volume, use the Alpha Wheel, or **−** & **+** buttons. Split Volume can be set to any number between -127 and 127.

Pressing the **Value Jump** button pair (**−** & **+**) resets the volume to 0.

#### Split Key

This sets the keyboard key that will be the boundary between the left and right hand Zones on the keyboard. The selected key will be the highest note for the left-hand Split Program. All keys higher than the Split Key will play the right-hand Zone(s). By default, the Split Key is set to B3. The Split Key can be selected using **Assign** , by holding down the **Assign** button and then striking the desired key on the keyboard. The Split Key can also be selected by using the Alpha Wheel, or **−** & **+** buttons. Split Key can be set to any key between A0 and C8.

#### Split Transpose

Hit the **Param/Channel** button to select the Split Transpose parameter. This allows you to transpose the left-hand Split Program in octaves so that you can play it in higher or lower octaves. Use the Alpha Wheel or **−** & **+** buttons to set the Transpose value. Transpose can be set to -24, -12, 0, 12, and 24. By default, Split Transposition is set to +12.

## Saving a Split

After setting the Split parameters, press the **Save** button to the left of the display to begin the saving process. See Save User Multis (page 7-8) for details on saving. Once you have saved your Split, you can continue to add Split or Layer Zones to the Multi until you reach the maximum of four active Zones. Also, once you have saved your Split, you can edit controller assignments and other Multi parameters in Multi Edit Mode (see Multi Edit Mode on page 8-1 for details).

## The Layer Function

Pressing the **Layer** button while in Multi Mode performs the Layer Function. The Layer Function allows you to layer Multis such that more than one sound can be produced by striking one key.

When you create a Layer in a Multi, you are in fact activating a Zone within the current Multi. If the current Multi already has its maximum of four active Zones and you press the **Layer** function button, then a message will appear on the display indicating that you have reached the maximum of four active Zones. Once you have saved your Layer, you can continue to add Layer or Split Zones to the Multi until you reach the maximum of four active Zones.

The Layer Function is convenient, as you do not need to use Multi Edit Mode to configure Zone key ranges, Programs, and volumes. You can simply press the **Layer** button, and the Artis SE automatically activates another Zone in the Multi to layer with the previously active Zones. After this you can choose a “Layer Program” that will be used as the Program for newly activated Zone.

There are three parameters (described below) that determine the behavior of the Layer. Press one of the **Param/Channel** buttons to the right of the display to access each of the Layer parameters.

### **Layer Program**

The Layer Program parameter determines the program that will be layered on top of the previously active Zones.

Initially the last used Layer Program will be selected, or, if this is the first time using the Layer Function since power-up the default Layer Program (224 Add a Pad 2) will be selected. Choose a Layer Program using the Category and Program/Multi buttons, the Alpha Wheel, or the **—** & **+** buttons.

### **Layer Volume**

Press the **Param/Channel ▲** button to select the Layer Volume parameter. This determines the volumes of the Layer Program and the previously active Zone(s). By default, the Layer Volume is set to 0, which results in all Zones having the same volume. When set to a positive number, the volume for the previously active Zone(s) is decreased. When set to a negative number, the volume for the Layer Program is decreased. To set the Layer Volume, use the Alpha Wheel, or **—** & **+** buttons. Layer Volume can be set to any number between -127 and 127.

Pressing the **Value Jump** button pair (**—** & **+**) resets the volume to 0.

### **Layer Transpose**

Press the **Param/Channel ▲** button again to select the Layer Transpose parameter. This allows you to transpose the Layer Program in octaves so that it sounds octaves higher or lower than the other Zone(s) you are layering on top of. Use the Alpha Wheel or **—** & **+** buttons to set the Transpose value. Transpose can be set to -24, -12, 0, 12, and 24. By default, Layer Transposition is set to 0.

## Multi Mode

---

### Saving User Multis

#### Saving a Layer

After setting the Layer parameters, press the **Save** button to the left of the display to begin the saving process. See *Save User Multis on page 7-8* for details on saving.

Once you have saved your Layer, you can continue to add Split or Layer Zones to the Multi until you reach the maximum of four active Zones. Also, once you have saved your Layer, you can edit controller assignments and other Multi parameters in Multi Edit Mode (see Multi Edit Mode on page 8-1 for details).

#### Saving User Multis

To save changes to the current User Multi, or to save a changed Factory Multi to a User Category, press the **Save** button once.



You can save Multis with ID numbers from 257 to 512. When you initially press the **Save** button, Artis SE always selects the next available unused ID number and displays the current Multi name.

Before Saving, you can specify the ID number and rename the Multi. After specifying the Multi ID number and name, press the **Save** button again to complete the saving process.

#### Changing ID Numbers

To change the ID number turn the Alpha Wheel or use the **-** & **+** buttons to select the new ID number. You can also use the **Bank**, **Category** and **Program/Multi** buttons to select an ID number, which is useful for organizing User Multis by Category. To do this, first press a Bank and Category button, then press a Program/Multi button to select an ID within that category.

If you choose an ID that is already in use, you will see an asterisk in the display after the ID number. Press **Save** to overwrite the existing Multi, or choose a different ID.



## Naming a User Multi

To rename the new Multi press a **Param/Channel** button until you see “Rename Multi as:”. The current Multi name will appear with a cursor line under the first letter. Use the Alpha Wheel to select characters for the new Program name. Press the **+** or **–** button to move the cursor to another character.



Multi names can total 16 characters in length. Choosing a Space character, or pressing Program/Multi button **6** will change the current character to a space. Pressing Program/Multi button **7** will insert a space, moving the selected character to the right and deleting the rightmost character if needed. Pressing Program/Multi button **8** will delete the selected character, moving all characters to the left.

## Completing a User Multi Save

Press the **Save** button to complete the saving process, or press the **Exit** button to exit without saving.

If you press a Mode button to switch Modes before you save the Multi, the display will show a message. Press **Save** to continue in Save mode, or **Assign** to save the Multi with the current settings, or **Exit** to cancel without saving.



After successfully saving, the Multi will be selected in Multi Mode in the User Bank. To find the Multi again later, make sure to press the **User** bank button while in Multi Mode.

# Chapter 8

## Multi Edit Mode

This chapter will help you familiarize yourself with the features of Multi Edit Mode.

### About Multi Edit Mode



**NOTE:** Before you read this chapter, be sure to read *Multi Mode on page 7-1* for a full description of Multis.

Multi Edit Mode allows you to edit and create Multis—it gives you access to a Multi’s common parameters and Zone-specific parameters. In this Mode, you can customize the Program, controller assignments, and MIDI transmit channel (in addition to many other parameters) of the Zones in a Multi. Any Multi edited or created in Multi Edit Mode is saved to one of the 256 User locations.

To enter Multi Edit Mode press the **Multi** button followed by the **Edit** button. While you are in Multi Edit Mode, the Multi button and Edit button LEDs are lit.

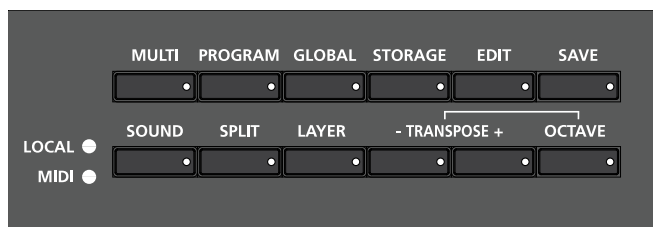

## Multi Edit Mode

### The Parameters List

# The Parameters List

A Multi has 86 Zone-specific parameters for each of the four Zones, and four common parameters—together, the configurations of these multiple parameters determine the behavior of the Multi. As you scroll through the list of parameters using the **Param/Channel Up ▲** button, the parameters appear in the following order (the parameters of course appear in the reverse order if you scroll through the list with **Param/Channel Down ▼** button):

List No.	Parameter	Range of Values	Default Value
1	Local Program	Program List	1 Concert Piano
2	Channel	1 to 16	1
3	Destination	Local, MIDI, Local+MIDI	Local+MIDI
4	Zone Status	Active, Muted	Active
5	Entry Volume	None, 0 to 127	127
6	Entry Pan	None, 0 to 127	None
7	Aux Send Level1	Prog, 0 to 127	Prog
8	Zone Channel FX	Enabled, Disable	Enabled
9	Transpose	-128 to 127 ST	0
10	Low Key	C-1 to G9	C-1
11	High Key	C-1 to G9	G9
12	Low Velocity	1 to 127	1
13	High Velocity	0 to 127	127
14	Note Map	Off, Linear, Constant	Linear
15	MIDI Bank	0 to 127	Bank of Local Program
16	MIDI Program	0 to 127	Program Number of Local Program
17	Entry Program Change	Off, On	On
18	Bank Mode	None, Ctl0, Ctl32, Ctl0/32, K2600	Ctl0/32
20	Bend Range Up	Prog, 0 to 127 ST	2 ST
19	Bend Range Down	Prog, 0 to 127 ST	12 ST
21	Mod Wheel Destination	Multi Destination Controller List	(none)
22	Mod Wheel Entry Value	0 to 127	(none)
23	Mod Wheel Exit Value	0 to 127	(none)
24	Slider 1 Destination	Multi Destination Controller List	(none)
25	Slider 1 Entry Value	0 to 127	(none)
26	Slider 1 Exit Value	0 to 127	(none)
27	Slider 2 Destination	Multi Destination Controller List	(none)
28	Slider 2 Entry Value	0 to 127	(none)
29	Slider 2 Exit Value	0 to 127	(none)
30	Slider 3 Destination	Multi Destination Controller List	(none)
31	Slider 3 Entry Value	0 to 127	(none)
32	Slider 3 Exit Value	0 to 127	(none)
33	Slider 4 Destination	Multi Destination Controller List	(none)
34	Slider 4 Entry Value	0 to 127	(none)
35	Slider 4 Exit Value	0 to 127	(none)
36	Slider 5 Destination	Multi Destination Controller List	(none)
37	Slider 5 Entry Value	0 to 127	(none)
38	Slider 5 Exit Value	0 to 127	(none)
39	Slider 6 Destination	Multi Destination Controller List	(none)
40	Slider 6 Entry Value	0 to 127	(none)
41	Slider 6 Exit Value	0 to 127	(none)
42	Slider 7 Destination	Multi Destination Controller List	(none)
43	Slider 7 Entry Value	0 to 127	(none)
44	Slider 7 Exit Value	0 to 127	(none)
45	Slider 8 Destination	Multi Destination Controller List	(none)
46	Slider 8 Entry Value	0 to 127	(none)
47	Slider 8 Exit Value	0 to 127	(none)

List No.	Parameter	Range of Values	Default Value
48	CC Pedal Destination	Multi Destination Controller List	(none)
49	CC Pedal Entry Value	0 to 127	(none)
50	CC Pedal Exit Value	0 to 127	(none)
51	Pedal Switch1a Mode	Momentary, Toggled	Toggled
52	Pedal Switch1a Destination	Multi Destination Controller List	(none)
53	Pedal Switch1a On Value	0 to 127	127
54	Pedal Switch1a Off Value	0 to 127	0
55	Pedal Switch1a Entry	None, On, Off	None
56	Pedal Switch1a Exit	None, On, Off	None
57	Pedal Switch1b Mode	Momentary, Toggled	Toggled
58	Pedal Switch1b Destination	Multi Destination Controller List	(none)
59	Pedal Switch1b On Value	0 to 127	127
60	Pedal Switch1b Off Value	0 to 127	0
61	Pedal Switch1b Entry	None, On, Off	None
62	Pedal Switch1b Exit	None, On, Off	None
63	Pedal Switch2a Mode	Momentary, Toggled	Toggled
64	Pedal Switch2a Destination	Multi Destination Controller List	(none)
65	Pedal Switch2a On Value	0 to 127	127
66	Pedal Switch2a Off Value	0 to 127	0
67	Pedal Switch2a Entry	None, On, Off	None
68	Pedal Switch2a Exit	None, On, Off	None
69	Pedal Switch2b Mode	Momentary, Toggled	Toggled
70	Pedal Switch2b Destination	Multi Destination Controller List	(none)
71	Pedal Switch2b On Value	0 to 127	127
72	Pedal Switch2b Off Value	0 to 127	0
73	Pedal Switch2b Entry	None, On, Off	None
74	Pedal Switch2b Exit	None, On, Off	None
75	Switch 1 Destination	Multi Destination Controller List	0
76	Switch 1 Mode	Momentary, Toggled	None
77	Switch 1 On Value	None, 0 to 127	None
78	Switch 1 Off Value	None, 0 to 127	Toggled
79	Switch 1 Entry	None, On, Off	(none)
80	Switch 1 Exit	None, On, Off	127
81	Switch 2 Destination	Multi Destination Controller List	0
82	Switch 2 Mode	Momentary, Toggled	None
83	Switch 2 On Value	None, 0 to 127	None
84	Switch 2 Off Value	None, 0 to 127	Toggled
85	Switch 2 Entry	None, On, Off	(none)
86	Switch 2 Exit	None, On, Off	127

List No.	Common Parameter	Range of Values	Default Value
87	Aux Effect	None, 1 to 9999	None
88	Aux Effect Channel	(Channels used in Multi)	(Channel of Zone 1)
89	KB3 Channel	1 to 16	(Channel of Zone 1)
90	Tempo	20 to 320	120



# Selecting Parameters

## The Display

In Multi Edit Mode, the top line of the display shows the current Mode, Zone number and the current parameter number as well as the total the number of available parameters. The bottom line of the display shows the current parameter and value.



### Scrolling Messages

Some parameters (such as Local Program) may be too long for the display, and will appear as scrolling text on the lower line.

## Param/Channel Buttons

Use the **Param/Channel** ▲ and ▼ buttons to scroll through the parameter list.

## Alpha Wheel and Value buttons

Use the Alpha Wheel or the – & + buttons below the wheel to change the parameter value—turning the Alpha Wheel counter-clockwise or pressing the – button will select the previous value and turning the Alpha Wheel clockwise or pressing the + button will select the next value.

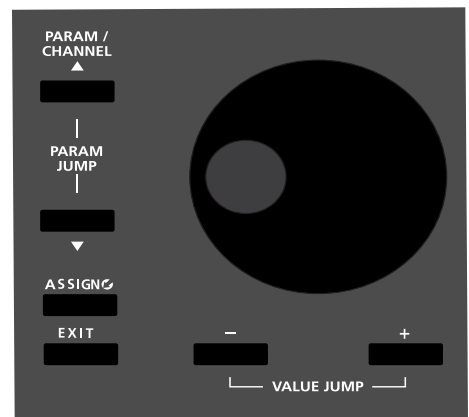

## Value Jump Buttons

Pressing the + and – buttons simultaneously resets the parameter to its default value.

## Param Jump Buttons

Pressing the **Param/Channel** ▲ and **Param/Channel** ▼ buttons simultaneously jumps parameters to specific jump points. The jump points are: Local Program, Transpose, Low Key, ModWheel Destination, Slider1 Destination, Slider6 Destination, Slider11 Destination, Pedal Switch Destination, Aux Effect Override (Common).

## Assign

In Multi Edit Mode, pressing and holding the **Assign** button while pressing a switch, key, or moving a controller performs Assign in the following cases:

### Assign + Zone (1–4) Button

Pressing and holding the **Assign** button while pressing one of the four **Zone** buttons will select that Zone for editing. The currently selected parameter will be shown for the selected Zone. If the current parameter is a Multi common parameter and not a Zone parameter, **Assign + Zone** button will not do anything.

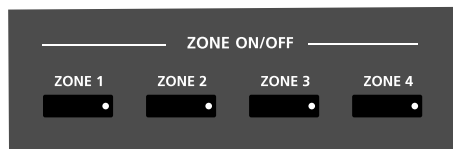

### Assign + controller

Pressing and holding the **Assign** button while moving a controller (a slider, SW button, Mod Wheel or any pedal) jumps to selecting the first parameter of that controller in the current Zone. This allows you to quickly assign a controller to a destination.

To edit the currently selected parameter, simply use the **–** & **+** buttons below the Alpha Wheel. Pressing Value Jump (both **–** & **+** buttons simultaneously) will jump to a different value depending on the parameter.

### Assign + key

With the LoKey or HiKey parameter selected, hold the **Assign** button and strike a key on the keyboard to set the LoKey or HiKey.

## The Zone-specific Parameters

Each of the four Zones in Multi has multiple parameters that determine its behavior. Since the Zones of a Multi are independent of each other, changing a parameter for a certain Zone will not affect the parameters of any other Zone.

### Local Program (Local Prog)

The Local Program parameter determines the Program to be loaded for the currently selected Zone. You can set this parameter to any Artis SE Program (0 – 512). The display shows the Program number and name (usually scrolling text).

Editing this parameter also changes the MIDI Bank and MIDI Program parameters, described below.

## Channel

The Channel parameter determines the MIDI transmit channel for the currently selected Zone. You can set this parameter to any of the 16 MIDI channels (1-16). You can assign different Zones to the same channel, but only one Program can be loaded in a channel at a particular time.

## Destination (Dest)

The Destination parameter determines whether MIDI data generated by the currently selected Zone is sent to the Artis SE sound engine, through the MIDI OUT port, or both. You can set this parameter to any of the three destinations for this parameter:



**NOTE:** In the table below, MIDI OUT applies to both the 5-pin MIDI OUT and the USB ports.

<b>Local</b>	MIDI data is sent only to the Artis SE sound engine. MIDI OUT is disabled.
<b>MIDI</b>	MIDI data is sent only through MIDI OUT. The sounds of the Artis SE are disabled.
<b>Local+MIDI</b>	MIDI data is sent both to the Artis SE sound engine and through the MIDI OUT.

Select the desired destination depending on your needs. If you want to play the Artis SE, but not send any MIDI information to other MIDI instruments, then select Local. If you want to use the Artis SE strictly as a MIDI controller for the other modules in your MIDI chain, then select MIDI. If you want to make use of the Artis SE's sounds as well as use it as a MIDI controller, then select Local+MIDI.

## Zone Status (Status)

The Zone Status parameter determines whether the currently selected Zone is active or muted. You can set this parameter to either of two states: Active or Muted. Use the Alpha Wheel to make your selection.

## Entry Volume (EntryVol)

The Entry Volume parameter determines the Volume MIDI message that the currently selected Zone sends when the Multi is loaded. You can set this parameter to any volume setting from **None**, **0** to **127**.

## Entry Pan

The Entry Pan parameter determines the Pan MIDI message that the currently selected Zone sends when the Multi is loaded. You can set this parameter to any pan setting from None, 0 (full left pan) to 127 (full right pan). To pan to center, select 64 for this parameter.

## Aux Send Level (AuxSendLvl)

The Aux Send Level parameter determines the auxiliary effects send level for the Program of the currently selected Zone. You can select any level from Prog, 0 to 127.

Pressing both - & + buttons simultaneously will set this parameter to 10. A value of Prog uses the default Aux Send Level that the current Zone's Program uses in Program mode. To enter a value of Prog, use the Alpha Wheel or - & + buttons to scroll lower than 0.

For a description of the auxiliary effects of a Multi, see *"About Auxiliary Effects" on page 8-15* and *Common Parameters on page 8-15*.

## Zone Channel Effects (ZnChanFX)

Use the ZnChanFX parameter to enable or disable the Insert effects Chain of the Program in each Zone. Some Zones set to Enable may be displayed as (Enable). This means that there are not enough effects resources available for that Zone, and that Zone's Insert effects are not loaded. If you want to use the Insert effects Chain for a Zone displayed as (Enable), try setting other Zones to Disable.

## Transpose (Xpose)

The Transpose parameter determines the transposition for the currently selected Zone. You can set this to any value from -128 semitones to 127 semitones.

## Low Key (LoKey)

The Low Key parameter determines the lower boundary of the currently selected Zone. You can set this parameter to any note from C-1 to G9.

If, for example, you set Low Key to C4, then only keys at or above C4 will trigger a note for the currently selected Zone. Keys below C4 will not trigger a note.

## High Key (HiKey)

The High Key parameter determines the higher boundary of the currently selected Zone. You can set this parameter to any note from C-1 to G9.

## Multi Edit Mode

---

### The Zone-specific Parameters

If, for example, you set High Key to C4, then only keys at or below C4 will trigger a note for the currently selected Zone. Keys above C4 will not trigger a note.

### Low Velocity (LoVel)

The Low Velocity parameter determines the lowest velocity that a keystroke must have in order to trigger a note in the currently selected Zone.

If, for example, you set Low Velocity to **20**, then only keystrokes with velocities of **20** or above will trigger a note. Keystrokes with velocities lower than **20** will not trigger a note.

### High Velocity (HiVel)

The High Velocity parameter determines the highest velocity that a keystroke can have in order to trigger a note in the currently selected Zone. You can set this parameter to any velocity between **0** and **127**.

If, for example, you set High Velocity to **80**, then only keystrokes with velocities of **80** or below will trigger a note. Keystrokes with velocities higher than **80** will not trigger a note.

### Notemap

Notemap lets you change the way notes are sent from the Artis SE.

A setting of Off, no notes are sent but controllers and other non-note data are. If you set Notemap to Constant, all of the keys on the keyboard will play the same note. A Notemap setting of Constant is useful for layering a single drum sound over another Zone, for example layering a ride cymbal over a Zone containing a Bass program. The note defaults to C4, but you can change this with the Transpose parameter.

With Notemap set to Linear, all notes go out as played.

### MIDI Bank

The MIDI Bank parameter determines the MIDI Bank change message that the currently selected Zone sends when the Multi is loaded. You can set this parameter to a MIDI Bank change message from **0** to **127**.

When using the Artis SE as a MIDI controller, sending a MIDI Bank change message (along with a MIDI Program change message) when a Multi is loaded ensures that the Program loaded on the other sound modules in your MIDI chain is the Program that you want. For example, if you've configured a Multi to work in a specific way with Program **32** in Bank **5** of a connected sound module, then set MIDI Bank to **5** and MIDI Program to **32**. This way, whenever you load this Multi, the sound module will automatically load Program **32** in Bank **5**.



**NOTE:** When you change the Local Program parameter, the MIDI Bank and MIDI Program parameters will automatically change to match the Bank and Program numbers of the Program that you select for Local Program. For example, if you choose Program 178, then MIDI Bank will change to 1 and MIDI Program will change to 49.

## MIDI Program

The MIDI Program parameter determines the MIDI Program change message that the currently selected Zone sends when the Multi is loaded. You can set this parameter to a MIDI Program change message from **0** to **127**.

When using the Artis SE as a MIDI controller, sending a MIDI Program change message (along with a MIDI bank change message) when a Multi is loaded ensures that the Program loaded on the other sound modules in your MIDI chain is the Program that you want. For example, if you've configured a Multi to work in a specific way with Program 32 in Bank 5 of a connected sound module, then set MIDI Bank to 5 and MIDI Program to 32. This way, whenever you load this Multi, the sound module will automatically load Program 32 in Bank 5.



**NOTE:** When you change the Local Program parameter, the MIDI Bank and MIDI Program parameters will automatically change to match the Bank and Program numbers of the Program that you select for Local Program. For example, if you choose Program 178, then MIDI Bank will change to 1 and MIDI Program will change to 49.

## Entry Program Change (EntryPrgChg)

The Entry Program Change parameter determines whether or not the currently selected Zone will send a MIDI Program change message when the Multi is loaded. You can set this parameter to either Off or On. When set to On, the Zone will send a MIDI Program change message with the Program specified for the MIDI Program parameter (described above).

## Bank Mode

The Bank Mode parameter determines the controller number with which MIDI Bank change messages are transmitted. For MIDI Bank change messages, various manufacturers have chosen different MIDI controller numbers. Most have chosen 0, 32, or both. In the case of the Kurzweil K2600, it has its own unique controller number that it responds to. You can set this parameter to any of the five controller IDs listed below:

<b>None</b>	MIDI Bank change messages are disabled.
<b>Ctl0</b>	MIDI Bank change messages are sent with controller number 0.
<b>Ctl32</b>	MIDI Bank change messages are sent with controller number 32.
<b>Ctl0/32</b>	MIDI Bank change messages are sent with both controller numbers 0 and 32.
<b>K2600</b>	MIDI Bank change messages are sent with controller number 32. (K2600 Program numbers 0-99.)

## Bend Range Down (BendRngDwn)

The Bend Range Down parameter determines the lower bend of the Pitch Wheel. You can set this parameter to any value between 0 semitones and 127 semitones, or to Prog, which uses the Bend Range of the currently selected Program for the Zone.

## Bend Range Up (BendRngUp)

The Bend Range Up parameter determines the upper bend of the Pitch Wheel. You can set this parameter to any value between 0 semitones and 127 semitones, or to Prog, which uses the Bend Range of the currently selected Program for the Zone.

## Continuous Controller Parameters

- Mod Wheel
- Sliders 1 through 8
- CC Pedal

### Destination (Dest)

Use the Destination parameter to assign the Artis SE physical controllers (Sliders, Pedals, Switches, Mod Wheel, etc.) to control Program parameters or send MIDI continuous controller messages (CCs) to external MIDI gear.

The Destination parameter determines the MIDI CC controller number that a physical controller will send to the Program in the currently selected Zone. By default, these CC messages are also sent to the MIDI Out and USB ports on the Channel of that Zone

The list of CC controller numbers below shows the default assignments for each destination. Programs respond to some of these CCs to do standard MIDI functions like volume and panning. Other external MIDI gear (sound modules, computer software) may respond to standard MIDI CC messages as well.

Controller Number	Controller Destination	Description
0	Bank	MIDI Bank change message.
1	MWheel	Default destination for Mod Wheel
2	Breath	Default assignment for breath controller in compatible synths
3	MIDI 03	MIDI Controller 3
4	Foot	Default assignment for continuous foot controller in compatible synths
5	PortTim	Monophonic Artis SE Programs respond to this Controller if portamento is turned on.
6	Data	MIDI Controller 6.
7	Volume	MIDI Volume
8	Balance	MIDI Balance
9	MIDI 09	MIDI Controller 9
10	Pan	MIDI Pan
11	Express	Default assignment for CC Pedal. In most Programs it acts as a volume control. It scales between 0 and the current value of Volume.
12	MIDI 12	Default assignment for Slider 5 (Filter-A Slider in Program Mode)
13	MIDI 13	Default assignment for Slider 6 (Filter-B Slider in Program Mode)
14-15	MIDI 14-15	MIDI Controllers 14-15
16-19	Ctl A - D	MIDI Controllers 16-19
20-26	MIDI 20-26	MIDI Controllers 20-26
27	MIDI 27	Default assignment for Slider 7 (FX-A Slider in Program Mode. Sometimes controls delay amount or another effect in Artis SE programs.)
28	MIDI 28	Default assignment for Slider 8 (FX-B Slider in Program Mode. Usually controls reverb amount in Artis SE programs.)
26	MIDI 29	Default assignment for SW 1 in Program Mode. Usually enables a pad layer or an effect in Program Mode.
30-31	MIDI 30-31	MIDI Controllers 30-31



## Multi Edit Mode

### The Zone-specific Parameters

Controller Number	Controller Destination	Description
32	MIDI Bank	MIDI Bank change message
33–63	MIDI 33–63	MIDI Controllers 33–63
64	Sustain	Default destination for Sustain Pedal
65	MIDI 65	MIDI Controller 65
66	Sostenut	Default destination for Sostenuto Pedal (Sustains notes that are currently down, but not notes played subsequently.)
67	Soft	Lowers the volume by a preset amount and may soften the timbre as well.
68	Legato	Forces mono playback.
69	Freeze	Envelopes freeze at current state.
70–83	MIDI 70–83	MIDI Controllers 70–83
84	Portamen	Standard MIDI controller for setting Portamento starting note
85	MIDI 85	Default assignment for SW 2 in Program Mode.
86–90	MIDI 86–90	MIDI Controllers 86–90
91	GMReverb	Adjusts reverb amount when controlling a General MIDI compliant synthesizer
92	MIDI 92	MIDI Controller 92
93	GMChorus	Adjusts chorus amount when controlling a General MIDI compliant synthesizer
94–95	MIDI 94–95	MIDI Controllers 94–95
96	Data Inc	Equivalent to pressing the + Value button
97	Data Dec	Equivalent to pressing the – Value button
98	NRegParL	Non-Registered Parameter Least Significant Byte
99	NRegParM	Non-Registered Parameter Most Significant Byte
100	RegParL	Registered Parameter Least Significant Byte
101	RegParM	Registered Parameter Most Significant Byte
102–119	MIDI 102–119	MIDI Controllers 102–119
120	Sound Off	Stops all sound in the corresponding channel.
121	RstCtls	Resets Controllers to defaults in the corresponding channel.
122	Local	
123	Notes Off	Sends Note Off Message to all playing notes in the corresponding channel.
124	Poly	
125	Omni	
126	Mono On	Any value sets a polyphonic program to monophonic
127	Mono Off	Any value sets a monophonic program to polyphonic
128	Pitch	Values above 64 and below 64 bend the pitch up and down, respectively.
129	PitchRev	Values above 64 and below 64 bend the pitch down and up, respectively
130	PitchUp	Values above 0 bend the pitch up
131	PitchDwn	Values above 0 bend the pitch down
132	Pressure	Default Destination for Pressure
133	Tempo	Tempo
134	KeyNum	Triggers playback of notes by Key Number—e.g., C4 is 60. Send a velocity first with Destination 135, KeyVel.
135	KeyVel	Key Velocity
136	ProgInc	Program Increment—increments current Program number.

Controller Number	Controller Destination	Description
137	ProgDec	Program Decrement—decrements current Program number.
138	ProgGoto	Go to Program—selects Program.
139	SetupInc	Multi Increment—increments current Multi number.
140	SetupDec	Multi Decrement—increments current Multi number.
141	SetupGoto	Go to Multi—selects Multi.
142	Start	
143	Stop	
144	Continue	
145	TransUp	Transpose Up (ST)
146	TransDown	Transpose Down (ST)

### Controlling Program Parameter Assignments from Multi Mode

Commonly you will want to assign a physical controller in a Multi to control the same Program parameter that it controlled in Program Mode. In the Dest parameter list, destinations that are assigned to parameters for the Program of the current Zone will show the Program Parameter name instead of that Controller Destination's default name. Select one of these destinations to control an assigned Program parameter.

### Entry Value

The Entry Value parameter determines the value of the continuous controller that is sent as a MIDI message when the current Multi is loaded. You can set this parameter to any number between 0 and 127, or to None.

If Entry Value is set to None, when you load the current Multi the controller will be at whatever value it last had in that MIDI channel.

### Exit Value

The Exit Value parameter determines the value of the continuous controller that is sent as a MIDI message when the current Multi is exited. You can set this parameter to any number between 0 and 127, or to None.

If Exit Value is set to None, then when you leave the current Multi the controller will be at whatever value it last had in that MIDI channel.

## The Pedal Switch & Switch Button Parameters

- PdSw1a
- PdSw1b
- PdSw2a
- PdSw2b
- SW1 Button

## Multi Edit Mode

---

### The Zone-specific Parameters

- SW2 Button

The following are parameters that affect the behavior of the Pedal Switch and **Sw** button controllers.

#### Mode

The Mode parameter determines the switching action of the switch controllers. You can set this parameter either of three settings:

- Momentary** A momentary switch is one that is only in the “on” state when it is pressed. As soon as you release the switch, it goes into the “off” state.
- Toggled** A toggled switch is one that maintains its state after it is pressed. So, if the switch is currently in the “off” state, pressing it once will put it in the “on” state. Pressing it again will put it back in the “off” state.

#### Destination (Dest)

The Destination parameter determines the Controller Destination for the currently selected controller in the currently selected Zone. For a list of the Multi Destination Controllers and their descriptions, see *Destination (Dest) on page 8-11*.

#### On Value (OnVal)

The On Value is the MIDI value sent when the switch is set to On. You can set this parameter to any number between 0 and 127, or to None.

#### Off Value (OffVal)

The Off Value is the MIDI value sent when the switch is set to Off. You can set this parameter to any number between 0 and 127, or to None.

#### Entry State

The Entry State parameter determines the state of the switch controller that is sent as a MIDI message when the current Multi is loaded. You can set this parameter to **None**, **On**, or **Off**.

If Entry State is set to None, when you load the current Multi the controller will be at whatever value it last had in that MIDI channel.

#### Exit State

The Exit State parameter determines the state of the Pedal Switch that is sent as a MIDI message when the current Multi is exited. You can set this parameter to **None**, **On**, or **Off**.

If Exit State is set to None, then when you leave the current Multi the controller will be at whatever value it last had in that MIDI channel.

## About Auxiliary Effects

Programs and Multis both have an auxiliary effect. An auxiliary effect is an effect that is not in the direct path of the sound, but rather, it “receives” the sound, and then outputs effect-altered sound, which is mixed back with the original sound. The following diagram illustrates the signal path of a sound through the auxiliary effect:

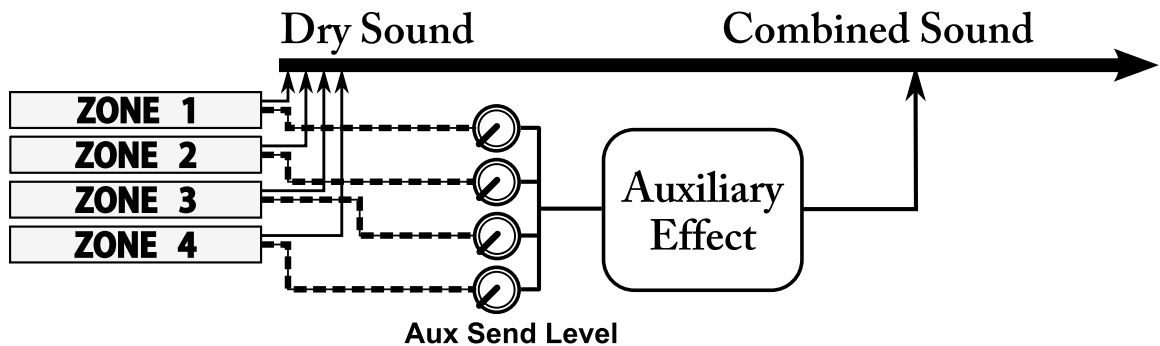

## Common Parameters

In addition to the Zone-specific parameters described above, a Multi has four parameters common to all of its Zones.

### Aux FX

Use the AuxFX parameter to select an Aux Effect Chain from the list that can be accessed by all Programs in the current Multi. Setting this parameter to anything other than “0 None” uses the selected Chain for the Aux Effect, and the Chain selected by the Aux FX Channel parameter is disabled. When the AuxFX parameter is set to “0 None”, the Aux Effect Chain for the Multi is determined by the Aux FX Channel parameter (described below.)

### Aux FX Channel (AuxFXCh)

In Program Mode, each Program has its own factory set Aux Effect Chain. Use the AuxFX Channel parameter to use a Program’s factory set Aux Effect Chain in Multi Mode. All programs in a Multi share one Aux Effect Chain.

To use a Program’s factory set Aux Effect Chain in Multi Mode, set the Aux FX Channel parameter to the MIDI channel of the Zone containing that Program.

If the AuxFX parameter is set to something other than “0 None”, the Chain selected with Aux FX Channel parameter is disabled. See the AuxFx parameter above for details.

## Multi Edit Mode

---

### Saving User Multis

#### KB3 Channel

In the event there are more than one KB3 Programs specified in a Multi, this parameter specifies which MIDI Channel has priority to load a KB3 Program. You can set this parameter to a value between 1 and 16.

#### Tempo

Some FX Chains that contain time based effects like delay or LFO can be synced to a tempo. Use the Tempo parameter to set a Tempo for the current Multi between 20 and 320 beats per minute. Pressing both **-** & **+** buttons simultaneously will set this parameter 120.

## Saving User Multis

For details on saving User Multis see “*Saving User Multis*” on page 7-8



# Chapter 9

## Global Mode

This chapter will help you familiarize yourself with the features of Global Mode.

Global Mode gives you access to the global parameters of the Artis SE—that is, it allows you to edit the master settings of the unit. It also allows you to restore factory defaults on the unit by performing a Hard Reset.



**CAUTION: Performing a Hard Reset will erase ALL User Programs, User Multis and reset Global settings to a factory state.**

To enter Global Mode from another Mode, press the **Global** Mode button. While you are in Global Mode, the **Global** button's indicator LED is lit.

When you enter Global Mode, the last selected parameter since power-up (or the Tune parameter if you're entering Global Mode for the first time since power-up) will be the currently selected parameter.

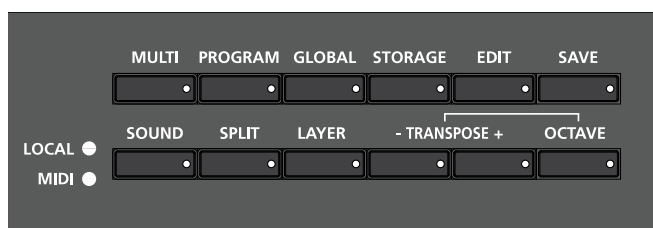

## Global Mode

### Selecting and Editing Parameters

# Selecting and Editing Parameters

To scroll through the parameters (and dialogs) of Global Mode, use the **Param/Channel** buttons.

Parameter or Dialog	Range of Values	Default Value
Tune	-100 to 100 Cents	0 Cents
Velocity Map	Linear, Light 1, Light 2, Light 3, Hard 1, Hard 2, Hard 3, Piano Touch, Easy Touch, GM Receive	Linear
FX Select (FXSel)	Performance, Multitrack	Performance
Auto Power Off	Enable, Disable	Enable
Auto Power Off Time	15min, 30min, 1hour, 2hour, 4 hour	4hours
Pedal Noise	Off, On	Off
Hard Reset?	(See corresponding section below)	
Soft Reset?	(See corresponding section below)	
Bank Select (BankSel)	0, 32, 0/32	0/32
Program Change (ProgChg)	On, Off	On
Channel Enable (Chan1–16)	Enable, Disable	Enable
Local Keyboard Channel (LclKbdChan)	None, 1 to 16	None
SysEx ID	0 to 127	3
OS/Objects	(See corresponding sections below)	
Delete Objects?		

To edit the currently selected parameter, use the Alpha Wheel or the **—** and **+** buttons. Pressing **Value Jump** (both **—** & **+** buttons simultaneously) will jump to a different value depending on the parameter—the jump value is mentioned in each of the parameter descriptions below. If you exit Global Mode (using the **Exit** button) and return to it before powering off, it will return to the last parameter you accessed previously.

## The Global Parameters

The following are the global parameters of the Artis SE. The settings of these parameters are in effect regardless of what Program or Multi you have currently selected.

### Tune

The Tune parameter allows you to fine-tune the unit in cents—one cent is one hundredth of a semitone (**100** cents comprise a semitone). You can select any tuning from **-100** cents to **100** cents. By default this parameter is set to **0**. Pressing **Value Jump** (– & + buttons simultaneously) will set this parameter to **0**.

### Velocity Map

The Velocity Map parameter determines the way the Artis SE generates MIDI velocity information. Different maps generate different MIDI velocity values for the same physical key strike velocity.

The default map (Medium) provides the widest range of velocity expression, but you may want to choose a different map if the default does not suit your playing style. You can select from any of the following settings:

<b>Lightest</b> <b>Lighter</b> <b>Light</b>	Makes it increasingly easier to produce high MIDI velocity values for the same key strike velocity (with Lightest being the easiest). These maps work best for those with a light touch.
<b>Medium</b>	The Artis SE default map. Medium, allows MIDI velocities to pass unchanged. It follows a linear response.
<b>Hard</b> <b>Harder</b> <b>Hardest</b>	Makes it increasingly harder to produce high MIDI velocity values for the same key strike velocity (with Hardest being the hardest). These maps work best for those with a heavy touch.
<b>Piano Touch</b>	Simulates the general velocity response of an acoustic piano, and is best suited for playing acoustic piano programs.
<b>Easy Touch</b>	Similar to the Light/Lighter/Lightest settings. Makes higher velocities easier to play, but allows more sensitive control over playing high velocities by not boosting the MIDI velocity for fast strike velocities as much as it does for medium strike velocities.
<b>GM Receive</b>	Mimics the velocity response commonly used by keyboards that use the General MIDI (GM) sound set. The GM Receive map makes medium strike velocities produce higher MIDI velocities compared to the Medium map.

Pressing **Value Jump** (– & + buttons simultaneously) will set this parameter to Medium.



## Global Mode

---

### The Global Parameters

## FX Select (FXSel)

The FX Select (FXSel) parameter determines how the Artis SE responds to interrupts with regards to effects. You can set this parameter to either Performance or Multitrack.

With FX Select set to Performance, the Artis SE minimizes disruption of existing effects when changing Programs, and entry values will not disrupt sustained notes when changing Programs in Program Mode.

When controlling the Artis SE from an external sequencer in Program Mode, setting FX Select to Multitrack will minimize effect disruption.

Pressing **Value Jump** (– & + buttons simultaneously) will set this parameter to Performance.

## Auto Power Off

The Auto Power Off parameter turns the power saving feature on. When the Auto Power Off parameter is set to Enable, the Artis SE will automatically power off after the Auto Power Off Time has expired, from the last key press (physical or MIDI), button press, controller movement, or USB MIDI activity.

## Auto Power Off Time

If the Auto Power Off parameter is set to Enable, then the Artis SE will power off after the time selected by the Auto Power Off Time parameter has elapsed.

The Artis SE will display warning messages, counting down before powering off.



Press a key or move any Artis SE control to dismiss the warning message. After dismissing this message, the Artis SE will wait the selected amount of time before showing this warning again.

## Pedal Noise

Some piano Programs have a Pedal Noise feature programmed into the sound. This parameter allows you to turn the Pedal Noise off if you prefer not to use it. If it is on, it will only activate noise on those Programs that have been programmed to use it.

## Hard Reset?

Hard Reset deletes all User Programs and Multis and resets all Global Mode parameters to their factory default settings. Before performing a Hard Reset, be sure to save your work to external storage (see Chapter 10 “*Storage Mode*”). Once deleted, User Programs and User Multis are completely removed from the Artis SE and can only be retrieved from external storage. Press the **+** button to begin the Hard Reset, and press **+** again to continue when the “Confirm?” message is shown.

<b>User PROGRAMs</b>	ALL USER PROGRAMS ARE DELETED.
<b>User MULTIs</b>	ALL USER MULTIS ARE DELETED.
<b>Global Mode</b>	ALL GLOBAL PARAMETERS ARE RESET TO THE ORIGINAL FACTORY DEFAULTS.

To exit the Hard Reset dialog, simply choose another parameter with **Param/Channel** buttons, or select the **Exit** button, or enter another Mode using the Mode buttons.

## Soft Reset?

Soft Reset restores all Global Mode parameters to their factory default settings without deleting User Multis or Programs. Press the **+** button to begin the Soft Reset, and press **+** again to continue when the “Confirm?” message is shown.

<b>User PROGRAMs</b>	No changes. Nothing is reset
<b>User MULTIs</b>	No changes. Nothing is reset.
<b>Global Mode</b>	ALL GLOBAL PARAMETERS ARE RESET TO THE ORIGINAL FACTORY DEFAULTS.

To exit the Soft Reset dialog, simply choose another parameter with **Param/Channel** buttons, or select the **Exit** button, or enter another Mode using the Mode buttons.

## Bank Select (BankSel)

The Bank Mode parameter determines the controller number with which MIDI Bank change messages are transmitted. For MIDI Bank change messages, various manufacturers have chosen different MIDI controller numbers. Most have chosen 0, 32, or both. You can set this parameter to any of the following three controller IDs: Pressing **Value Jump** (both **—** & **+** buttons simultaneously) will set this parameter to **0/32**.

- 0** MIDI Bank change messages are sent with controller number 0.
- 32** MIDI Bank change messages are sent with controller number 32.
- 0/32** MIDI Bank change messages are sent with both controller numbers 0 and 32.

## Program Change (ProgChg)

The Program Change (ProgChg) parameter determines whether or not entry MIDI Program Change messages are sent for Multis. You can set this parameter to either On or Off. Pressing **Value Jump** (both **—** & **+** buttons simultaneously) will set this parameter to On.

## Channel Enable

For each of the 16 MIDI channels, you can set the Channel Enable parameter to either Enable or Disable. For each channel, setting this parameter to Enable enables the channel to transmit and receive MIDI messages and setting it to Disable disables such functions. Pressing Value Jump (both **—** & **+** buttons simultaneously) will set this parameter to Enable.

## Local Keyboard Channel (LcIKbdChan)

Changing the setting of the Local Keyboard Channel parameter is useful only when the Artis SE is receiving MIDI information from an external source. Perhaps you have a favorite MIDI keyboard that you use to control all the gear in your studio, or you use a lot of outboard sequencing. If you're using the Artis SE as a standalone music workstation or performance keyboard, you can ignore this parameter and leave it set to None.

The local keyboard channel enables the Artis SE to receive MIDI information on a single channel, then rechannelize that information so you can play and control all four Zones of a Multi, even if your MIDI source transmits on only one channel.

## Program Mode

When you're in Program Mode, the local keyboard channel remaps incoming information to the Artis SE's current channel. This ensures that MIDI sent to the local keyboard channel will always play the Program on Program Mode's currently selected channel. When using the local keyboard channel all the MIDI information received on the Local Keyboard Channel also gets sent to the Artis SE's MIDI Out and USB ports on Program Mode's currently selected channel.

## Multi Mode

Things are a bit different for playing Multis. In this case, you must use the Local Keyboard Channel to be able to play and control all of the Multi's Zones. Set Local Key Channel to match the channel your external MIDI source is using (if for example your MIDI source transmits on Channel 1, set Local Key Channel to 1). All MIDI information that the Artis SE receives on the local keyboard channel gets remapped to the channels and control destinations used by the Zones in the Multi.

The Artis SE also remaps certain MIDI Controller messages that it receives on the Local Keyboard Channel, so that they correspond (in most cases) to the default assignments for the Artis SE's physical controllers (Mod Wheel, sliders, etc.). Physical controller assignments are handled by Multis, and are defined per Zone in Multi Edit Mode. Each Zone of a Multi has its own controller assignments.

Pressing **Value Jump** (both **—** & **+** buttons simultaneously) will set this parameter to None.

## Sysex ID

The SysEx ID parameter determines the ID number for the unit if you are using more than one device with the same MIDI manufacturer ID number. You can set this parameter to any number from 0 to 127.

Unless you have multiple Artis SEs receiving Sysex messages from a single source, you will not need to change the Sysex ID from the default setting of 0.

If you do have multiple Artis SEs receiving Sysex messages from a single source, make sure each Artis SE has a different Sysex ID. This will allow you to direct Sysex messages to the appropriate Artis SE by specifying which unit with the Sysex ID byte that's included with every Sysex message.

To have the unit respond to Sysex messages regardless of the Sysex ID, set Sysex ID to **127**. Pressing **Value Jump** (both **—** & **+** buttons simultaneously) will set this parameter to 0.

## Objects/OS

The will display the system information indicating what version of operating system and objects is currently installed in your Artis SE keyboard.

## Global Mode

---

### The Global Parameters

Go to the Kurzweil website at <http://www.kurzweil.com> and make sure that you have the latest operating system available.

## Delete Objects?

Use the Delete function to delete unwanted User Programs or Multis. Deleted Program/Multis can not be restored (see the Storage Mode chapter if you wish to store User Programs/Multis to an external device before deleting). With “Delete Objects?” selected, press the **+** button to view the Delete list. Use the **Param/Channel** buttons to step through the list and select a User Program or Multi. Press the **+** button to delete the selected Program or Multi, and you will see the “Are you sure?” message. Press the **+** button again to delete the Program/Multi, or press the **–** button to cancel and return to the Delete list.

# Chapter 10

## Storage Mode

There are four functions within Storage Mode: Use the **Param/Channel** buttons to step through the Storage options:

- Device
- Store?
- Load (Overwrite)?
- Load (Fill)?

### Device

Use the Device option to select a device to store to or load from. Two connections are provided on the rear panel of the Artis SE. The Computer port is used to communicate with a computer or tablet; the Storage port will accept a USB storage device such as a thumb drive. Make sure the device is connected, then use the **—** & **+** buttons to select the desired device. Select PC to load/store via a computer/tablet using a connected USB cable, or select USB to load/store using a connected USB storage device.

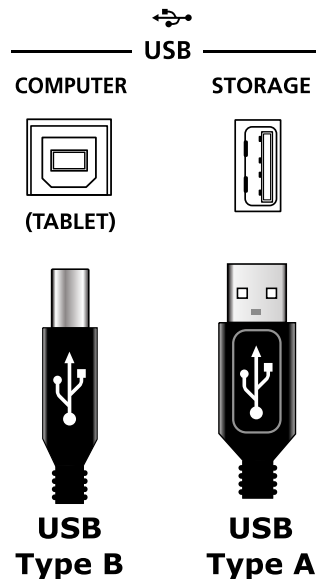



**NOTE:** Selecting PC for the Device option will disconnect any MIDI device connected via USB. If the Artis SE is currently connected to your computer via USB as a MIDI device, you may want to close any MIDI applications connected to the Artis SE in order to avoid problems when MIDI is disconnected.

### Store?

The **Store?** option allows you to save every User Program and User Multi to a device connected to the unit via USB. After selecting a device with the Device option, connect a USB cable or USB device to a USB port on the Artis SE's rear panel.

With the **Store?** option selected, press the **+** button and the display will show the message "Save file to [device]?". Press the **+** button again to start the process of saving the files to the selected device (USB or PC). If the device is not attached or not recognized, the display will prompt you to connect the selected device or unplug and reconnect it. Follow the instructions on the display.

When the device has been recognized, the display shows the default file name for all objects (**ALLOBJTS**). You can edit this before saving, using the **+** button to move the cursor, and the Alpha Wheel to select alphanumeric characters.

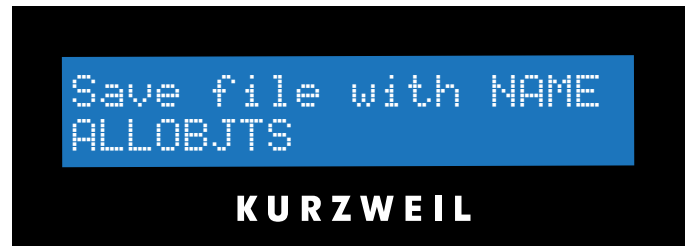

Press the **Save** button or the **Assign** button to store your user objects to the selected device (or press **Exit** to cancel). The display will show the "Saving..." message then a confirmation. If you are storing to a PC, you must copy the saved file from the Artis SE virtual drive to your computer before continuing.



If an error occurs during the save operation, then the display will show the error message, **Save Error**.

## Load (Overwrite)?

The `Load (Overwrite)?` option allows you to load a file containing previously saved User Programs and User Multis from a device connected to the Artis SE via USB. Selecting `Load (Overwrite)?` loads the previously saved User Programs and User Multis and deletes (overwrites) the existing User Programs and Multis currently in the Artis SE. If there are fewer objects in the file than are currently stored in User locations, the additional locations will be emptied.

Press the **+** button to begin the process of loading from the selected device (USB or PC). If the device is not attached or not recognized, the display will prompt you to connect the selected device or unplug and reconnect it. Follow the instructions on the display. If PC was selected for the Device option, then the Artis SE will appear as a removable disk/drive on your computer. Copy the file, containing your previously saved User Programs and User Multis, from your computer into the Artis SE removable disk/drive. If USB was selected for the Device option, use the Param/Channel **▲** or **▼** buttons to select the file to load from the list of files on the Artis SE display.



Press **Assign**, and a warning message will appear before executing the Overwrite:



Pressing **Assign** again will load the file; pressing **Exit** (or the **—** button) will cancel the process without overwriting the current files, and return to the `Load (Overwrite)?` option.

When loading new files the display shows `File Loading...`, and when complete `File loaded`.

If no file is in the Artis SE temporary drive during the load or an error occurs during the load operation, then the display will show the error message, `Load Error` and a message specifying the reason for the error.



### Load (Fill)?

The Load (Fill)? dialog allows you to load a file containing previously saved User Programs and User Multis from a device connected to the unit via USB. The loaded User Programs and User Multis will fill any available location.

With the Load (Fill)? option selected, press the **+** button to begin the process of loading from the selected device (USB or PC). If the device is not attached or not recognized, the display will prompt you to connect the selected device or unplug and reconnect it. Follow the instructions on the display. If PC was selected for the Device option, then the Artis SE will appear as a removable disk/drive on your computer. Copy the file, containing your previously saved User Programs and User Multis, from your computer into the Artis SE removable disk/drive.

If USB was selected for the Device option, use the Param/Channel **▲** or **▼** buttons to select the file to load from the list of files on the Artis SE display. For either device, pressing the **+** button will load the file, the display shows "File Loading...", and when complete "File loaded."

Pressing **Exit** (or the **—** button) will cancel the load operation and recall the Load (Fill)? dialog.

If no file is in the Artis SE temporary drive during the load or an error occurs during the load operation, then the display will show the error message, Load Error and a message specifying the reason for the error.

# Chapter 11

## System Mode (Boot Loader)



**CAUTION:** DO NOT ATTEMPT TO MAKE ANY CHANGES IN SYSTEM MODE UNTIL YOU HAVE READ AND FULLY UNDERSTOOD THIS ENTIRE CHAPTER.

System Mode allows you manage and upgrade the OS software of your Artis SE as well as perform diagnostic tests of the instrument's various internal systems and processes. The functions that you have access to in System Mode govern the operation of your Artis SE, so use System Mode only when you must perform essential maintenance tasks.

To enter System Mode, follow these steps:

1. Power off your Artis SE.
2. Press and the hold the **Assign** button, and power on the unit. The display will show the text "Loading..." then "Entering bootloader..." Make sure to keep holding the **Assign** button until the display shows a screen like the following (your system version may differ):



3. Release the **Assign** button—at this point, you are in System Mode.

System Mode includes the following five menu options:

- Run Artis SE
- Update Software
- Run Diagnostics
- System Reset
- File Utilities



**CAUTION: THE SYSTEM RESET AND FILE UTILITIES OPERATIONS BOTH ERASE ALL USER OBJECTS.**

## System Mode Buttons

The navigation buttons perform the following functions in System Mode:

<b>Exit</b>	Use the <b>Exit</b> button to return to the previous menu. Similar to a “cancel” button.
<b>+</b>	Use the <b>+</b> button to confirm a selection and move into sub-menu, if any. It functions like an “OK” button.
<b>Param/Channel ▲</b>	Use the <b>Param/Channel ▲</b> button to select the next menu item, menu item parameter or read Diagnostic test messages.
<b>Param/Channel ▼</b>	Use the <b>Param/Channel ▼</b> button to select the previous menu item, menu item parameter or read Diagnostic test messages.

## Run Artis SE

This is the first System Mode menu item. Pressing the **+** button will load the OS and the Artis SE will start up as if you just switched on the unit (except for the **Loading...** message that happens when you first start up the unit).

## Update Software

Update Software has two parameters: Update and Restore. Select Update to install a new OS and Objects version, or select Restore to the install the previous OS version. The new OS and Object files are combined in one file (.KUF).

### Update

1. Obtain the Update file from the Kurzweil website or another reliable source and save it in a known folder or directory on your computer.
2. Connect the Artis SE (powered off) to your computer with a USB cable.

3. Follow the instructions specified on *page 11-1* to enter System Mode. The Artis SE will appear as a removable disk/drive on your computer.
4. Press the **Param/Channel ▲** button once. The display shows **Update Software**.
5. Press the **+** button once. The display shows **Update**.

To select Update, press the **+** button once. The display shows **Copy file To drive and press + to continue**. Copy the file to the Artis SE removable disk/drive on your computer. Once copied, “Safely Remove” or “Unmount” the removable disk/drive from your computer.

6. Press the **+** button on the Artis SE. If the .KUF file is valid, the Artis SE will display the message **Installing....** This will take a minute or two.
7. Once you see a **Done** message press the **Exit** button to return to the System Mode main menu.

## Restore

Whenever you update the Artis SE’s software, a backup of the currently installed software is made. This is in case of a need to revert back to the old software, such as if the new update has problems or for troubleshooting.



**NOTE:** Only the previously installed version of the software is backed up. When you perform a **Restore** operation again, the current version is backed up. So, it’s possible to go back and forth between versions.

Unlike the Update operation, the Restore operation can be performed without a computer connected to the Artis SE:

1. Follow the instructions specified on *page 11-1* to enter System Mode.
2. Press the **Param/Channel ▲** button once. The display shows **Update Software**.
3. Press the **+** button once. The display shows **Update**.
4. Press the **Param/Channel ▲** button again. This display shows **Restore**.
5. Press the **+** button to restore the previous software version.
6. Press the **Exit** button to cancel and return to the System Mode main menu.

## Run Diagnostics

You will most likely not need to use the Run Diagnostics operations in normal cases. These operations are mostly used at the factory and service centers by engineers for troubleshooting hardware problems. But, in some cases you might be required to run these diagnostics for troubleshooting and diagnosing symptoms. In these cases, following the direction of an authorized Kurzweil technician.

## System Reset



**CAUTION: THIS OPERATION ERASES ALL USER OBJECTS.**

If you've made many complex updates to your Objects, and have saved a number of files to your computer, you might want to restore the instrument to its default state. This is especially helpful if you're having problems getting Programs or Multis to work properly, or think there may be some kind of underlying hardware problem.

To clear all user objects and restore the factory default state, select the System Reset menu option. Press the **Param/Channel ▲** button until you see **System Reset** in the display, then press the **+** button. The display will scroll the message **Delete all user objects?**. Press the **+** button to reset the Artis SE, or press the **Exit** button to cancel.

Remember to save your User Programs and User Multis to your computer following the instructions in *Store? on page 10-2*. Once deleted, these files are completely removed from the Artis SE and there is no way to retrieve them.

## File Utilities



**CAUTION: THIS OPERATION ERASES THE OPERATING SYSTEM, ALL FACTORY OBJECTS AND ALL USER OBJECTS.**

File Utilities has only one operation: Format. Performing this operation will format the Artis SE's system flash memory and erase the OS software as well as *all* Objects. Do not do this unless you think it is necessary in order to improve the performance of your Artis SE. Should you decide to do so, be sure to back up all of your files and software. After you do this, System Mode will still be available, so you can run updates and get your Artis SE up-and-running again. After a Format the unit will come up in System Mode by default.

To perform a Format, follow these steps:

1. Follow the instructions specified on *page 11-1* to enter System Mode.
2. Press **Param/Channel Down ▼** button once. The display shows **File Utilities**. Press **+** to select this operation. The unit display the message **Format Flash**.
3. Press the **+** button to format the Artis SE.
4. Press the **Exit** button to cancel and return to the System Mode main menu.

# Chapter 11

## Troubleshooting

### Maintenance

Aside from normal care in handling and use, your Artis SE requires no regular maintenance. Clean with a soft cloth dampened with water. Never use abrasives or solvents as they may damage the unit's paint, markings and display lens. There are no batteries inside to replace—ever. Instead of volatile SRAM used in most other instruments, your Artis SE uses nonvolatile Flash Memory for storage, which retains information without power.

### Common Problems

Below is a list of the most commonly encountered problems and diagnoses for each.

#### Power Problems

This is the normal power-up sequence:

1. The display backlight turns on.
2. “Loading...” appears on the display for a few seconds.
3. The Artis SE enters Program Mode with Program 1 or the Category Default Program for the Piano1 category selected.

If nothing at all happens when you turn the power switch on, check if one of the following might be the issue:

**The power cable is not plugged securely into the wall outlet.**

Plug the power cable securely into the wall outlet.

**The power cable is not plugged securely into the Artis SE power jack.**

Plug the power cable securely into the Artis SE power jack.

## Troubleshooting

---

### Common Problems

**The wall outlet, power strip, or extension cord is defective or damaged.**

Use a different wall outlet, power strip, or extension cord.

If there's evidence of the unit receiving power, but operation is abnormal, check if one of the following might be the issue:

**The wall outlet voltage is below 90 volts due to overload.**

Try a different outlet on a different circuit.

### Powers up, Display is Blank

**The Display is blank or difficult to read.**

Slowly turn the Display contrast knob (located above the Alpha Wheel) to adjust the Display.

### Audio Problems



**CAUTION: Do not trouble shoot audio problems using headphones. Additionally, always be aware of the volume levels on the Artis SE and on the connected audio system or mixer.**



**NOTE: When diagnosing audio problems, set the Artis SE to play its Demo Song rather than intermittently pressing keys. This will prevent any unexpectedly loud volume changes.**

If there is no sound from your Artis SE, check if one of the following might be the issue:

**The volume slider is turned down.**

Slowly push the volume slider up.

**The volume control on the audio system or mixer is turned down.**

Slowly turn the volume control up.

**The signal source selection on the audio system or mixer is incorrect.**

Set the volume of the audio or mixer to the lowest level, select the correct signal source, and then slowly turn up the volume.



**The audio cables are not securely plugged into the Artis SE, audio system, or mixer.**

Set the volume of the audio or mixer to the lowest level, securely plug in the audio cables on both ends, and then slowly turn up the volume.

**The Sound parameter stops MIDI Data**

Use the Sound button switch to Local + MIDI.

**The audio cable is of an incorrect type.**

Obtain and securely connect an audio cable of the correct type. The Artis SE accepts both balanced (TRS) and unbalanced (TS) 1/4-inch audio cables.

If you can hear sound but it is low or distorted, check if one of the following might be the issue:

**The audio cables are not securely plugged into the Artis SE, audio system, or mixer.**

Set the volume of the audio system or mixer to the lowest level, securely plug in the audio cables on both ends, and then slowly turn up the volume.

**A received MIDI volume message has specified a low volume.**

Set the volume of the audio system or mixer to the lowest level. Disconnect all MIDI cables, press the Sound button to select Local or MIDI+Local, and reset the volume level on the Artis SE, by pressing Panic (see page 3-14). Finally, slowly turn up the volume level of the audio system or mixer.

**The current Multi has another controller assigned to volume, and it is turned down.**

Select a different Multi. Or change the problematic controller setting by editing the Multi in Multi Edit Mode.

**The input to the audio system is set for low impedance instead of high impedance.**

Set the volume of the audio or mixer to the lowest level, change the impedance setting, and then slowly turn up the volume of the audio system or mixer.

**The input trim to the audio system or mixer is set too low.**

Slowly turn up the trim.

## MIDI Problems

If you are experiencing problems sending MIDI to an external module, check if one of the following might be the issue:

**The MIDI cable is not securely plugged in at both ends.**

Securely plug in the MIDI cable at both ends.

**The MIDI connections are wrong.**

To send MIDI, plug the MIDI cable into the Artis SE' MIDI Out port and into the module's MIDI In port.

**The MIDI cable is defective.**

Obtain and securely connect a new MIDI cable.

**The MIDI transmit channel does not match that of the receiving device.**

Change the channel on either the Artis SE or on the device such that the channels match.

If there are problems with the internal sound module receiving MIDI from an external device like a computer sequencer, check if one of the following might be the issue:

**The MIDI transmit channel of transmitting device does not match that of the receiving Program or Zone on the Artis SE.**

Change the channel on either the Artis SE or on the computer such that the channels match.

**The MIDI cable is not securely plugged in at both ends.**

Securely plug in the MIDI cable at both ends.

**The MIDI connections are wrong.**

To receive MIDI, plug the MIDI cable into the Artis SE' MIDI In port and into the module's MIDI Out port.

## Pedal Problems

Before you consult this section, be sure to read *Connecting Pedals* page 2-6.

### Switch Pedal Problems

If you are having problems with connecting or using a switch pedal, check if one of the following might be the issue:

- Sustain or Sostenuto is stuck “on”. Be sure the pedal is plugged in before switching on the power. Turn power off, then on, if necessary.
- The pedal is acting backwards (“on” when up instead of down). Power cycle the unit making sure to NOT press on the pedal during startup.
- A dual switch pedal is not working correctly, see *Connecting a Dual Switch Pedal* on page 2-8. A dual switch pedal must be wired as shown below. Any other wiring pattern will not work correctly.

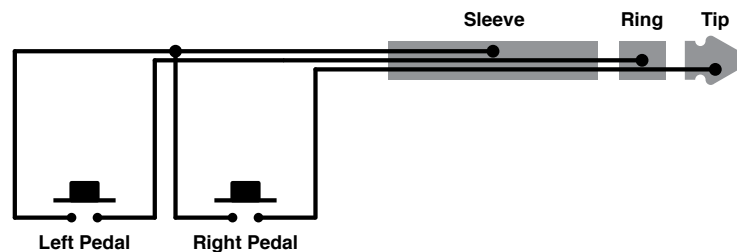

### Continuous Control and Half Damper Pedal Problems

The continuous control pedal must be wired to a single stereo 1/4-inch plug as follows:

- Wiper to Tip
- Top end of resistance element to Ring
- Bottom end of resistance element to Sleeve

These connections are shown schematically below:

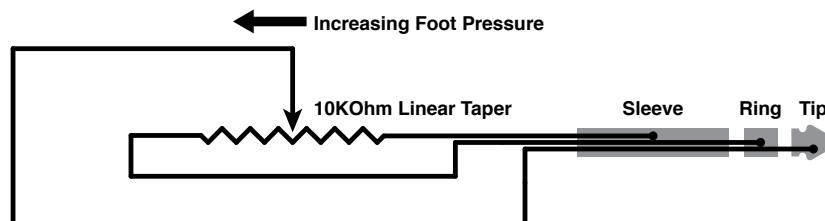

Use the correct impedance, taper, and range

## Troubleshooting

---

### If None of the Above...

For best results, use a Kurzweil CC-1 continuous control pedal, available from your dealer. The CC-1 meets all of the requirements described above at an economical price. A continuous control pedal should have an impedance between 5,000 and 100,000 ohms. An impedance less than 5,000 may overload the reference voltage source in the Artis SE and interfere with operation of other controls like the Master Volume slider or the other sliders. An impedance more than 100,000 may result in electrically noisy operation, which may cause your Artis SE to send MIDI controller messages constantly.

The taper of the control should be linear for easy, predictable control. Pedals designed for volume control typically have an exponential (or anti log) taper, which results in most of their range being concentrated in the upper half of pedal's path of travel.

Pedals may have a control range that is less than 100%. Make sure that when the pedal is in the fully down position, its impedance is 0, and when it is in the fully up position, the impedance is at its maximum rating.

## If None of the Above...

If your problem is not covered above, or none of the suggestions seems to work, first check back and review the relevant sections of this manual. Many difficulties are just programming problems caused by settings of Multi parameters. If you want to be sure that all of the factory defaults are in place, see Restoring Factory Defaults on page 12-6.

Also be sure to check out Kurzweil's website for additional Artis SE information that may have been published since this manual was written: [www.kurzweil.com](http://www.kurzweil.com).

If you still have problems, contact Kurzweil support in your country or at [www.kurzweil.com/support/](http://www.kurzweil.com/support/). You may also find unofficial help at some of the internet communities listed at [www.kurzweil.com/community/](http://www.kurzweil.com/community/).

## Service Centers

Contact the nearest Young Chang office Kurzweil service representative. See page iv in the front matter of this manual for contact information.

## Restoring Factory Defaults

There are two ways to restore factory defaults, both of which delete all User Programs and User Multis. The first method is described on page 9-5. The second is described in System Reset on page 11-4.



**CAUTION: Restoring factory defaults cannot be undone. Back up your files before doing so by following the procedure on page 10-2**

## **Diagnostics**

You will most likely not need to use the System Mode diagnostic operations in normal cases. These operations are mostly used at the factory and service centers by engineers for troubleshooting hardware problems. But, in some cases you might be required to run these diagnostics for troubleshooting and diagnosing symptoms. In these cases, follow the direction of an authorized Kurzweil technician.

# Appendix A

## MIDI Implementation

Function		Transmitted	Recognized	Remarks
Basic Channel	Default	1	1	Memorized
	Changed	1–16	1–16	
Mode	Default	Mode 3	Mode 3	Use Multi-track mode (see FX Select (FXSel) on page 9-4 for multitimbral applications)
	Messages			
	Altered			
Note Number			0–127	
	True Voice	0–127	0–127	
Velocity	Note ON	O	O	
	Note OFF	O	O	
Aftertouch	Keys	X	O	
	Channels	X	O	
Pitch Bender		O	O	
Control Change		0–31 32–63 (LSB) 64–127	0–31 32–63 (LSB) 64–127	Controller assignments are programmable
Program Change		0 to 2,097,151	0–511	Standard and custom formats
	True #	0–127	0–127	
System Exclusive		O	O	
System Common	Song Pos.	X	X	
	Song Sel.	X	X	
	Tune	X	X	
System Real Time	Clock	X	X	
	Messages	X	X	
Aux Messages	Local Control	O	O	
	All Notes Off	O	O	
	Active Sense	X	X	
	Reset	X	X	
Notes	Manufacturer's ID = 07 Device ID: default = 0; programmable 0–127			

Mode 1: Omni On, Poly  
Mode 3: Omni Off, Poly

Mode 2: Omni On, Mono  
Mode 4: Omni Off, Mono

O = Yes  
X = No

# Appendix B

## Physical Specifications<sup>1</sup>

<b>Keyboard:</b>	88-key, fully-weighted hammer-action with velocity sensitive keys. (Fatar TP/100).
<b>Display:</b>	20 x 2 character LCD with front-panel contrast adjust.
<b>Polyphony:</b>	128 Voice Polyphony, dynamically allocated.
<b>Multitimbral:</b>	16 parts (one per MIDI channel).
<b>Quick Split / Layer:</b>	Easy access with adjustable relative volume (up to 4 zones).
<b>Programs:</b>	256 Factory plus 256 User Programs.
<b>Multis:</b>	128 Factory Multis, plus 256 User Multi locations with 4 programmable zones for splits and layers.
<b>Effects:</b>	Over 1000 complex effect chains, incorporated into programs. 16 total FX units. Not editable, excepting Aux Override.
<b>Master EQ Section:</b>	Dedicated front-panel 3-band EQ with on/off switch
<b>Controllers:</b>	<ul style="list-style-type: none"> <li>• Front panel mounted Pitch and Modulation wheels</li> <li>• Volume Slider</li> <li>• 4 sliders</li> <li>• 2 programmable switch buttons</li> <li>• 2 Dedicated transpose switches</li> <li>• 2 switch pedal inputs** (1 switch/sustain pedal is included)</li> <li>• 1 continuous control pedal input</li> </ul> <p>(** Each switch pedal input supports a single or dual switch pedal, or a single half-damper* pedal. Half-damper for MIDI output only.)</p>
<b>Analog Outputs:</b>	<ul style="list-style-type: none"> <li>• Two 1/4" balanced TRS analog (24-bit DACs)</li> <li>• +21dBu maximum output</li> <li>• 400Ω balanced source impedance</li> </ul>
<b>Audio Inputs:</b>	One stereo 1/8" back-panel input
<b>Headphones:</b>	1 rear panel 1/4" headphone output; 130mW into 32 ohm headphones
<b>MIDI:</b>	IN, OUT
<b>USB:</b>	<ul style="list-style-type: none"> <li>• Complete MIDI functionality over USB</li> <li>• User program/multi file transfer to/from PC/Mac/Flash Drive</li> <li>• Operating System updates from PC/Mac/Flash Drive</li> </ul>
<b>FREE OS Updates</b>	Operating System updates from PC / Mac / USB Flash Drive
<b>Height:</b>	5.87" (14.9 cm)
<b>Depth:</b>	14.8" (37.6 cm)
<b>Length:</b>	50.63" (128.6 cm)
<b>Weight:</b>	38.6 lbs (17.5 kg)
<b>Power:</b>	External DC 15V 2.5A power Supply

<sup>1</sup> Specifications subject to change without notice

# Appendix C

## Factory Programs

### PIANO 1

ID	BANK A
1	Concert Piano
2	Rock Piano
3	Recital Piano
4	Bright Classical
5	Parlor Piano
6	Jazz Piano
7	Stadium Pop Pno
8	Radio Pop Pno

ID	BANK B
129	R&B Keys
130	Hip Hop Piano
131	EDM Piano
132	Soul Piano
133	Pub Piano
134	Indie Piano
135	Seventies Piano
136	Piano & Pad

### PIANO 2

ID	BANK A
9	Power Pop Piano
10	Big Rock Piano
11	Upright Piano
12	Blues Piano
13	Classic Rock Pno
14	Modern Rock Pno
15	NOLA Piano
16	Stage Piano

ID	BANK B
137	Piano & Choir
138	Piano & Harp
139	Film Piano
140	Ambient Piano
141	Dark & Distant
142	Delay Piano
143	Mono Piano
144	Triple Strike



# ELECTRIC PIANO 1

---

ID	BANK A
17	Stevie's EP
18	Duke's Dyno EP
19	Beaten in EP
20	Fagen Phaser
21	Hotrod Dyno EP
22	Sweet Loretta EP
23	EP/WahSW
24	XfadBelltoneEP

ID	BANK B
145	FM EP 1
146	FM EP 2
147	Elec Grand Stack
148	Rich EP+Pad
149	Crisp and Soft
150	Tight Bright FM
151	Gabriel's Melt
152	CP80 Enhanced

# ELECTRIC PIANO 2

---

ID	BANK A
25	WoodstockClunker
26	Stage Mix EP
27	Super EP
28	Darkside/Wah
29	What'd I SayEP
30	ACL EP
31	BrightDynamicEP2
32	DeepFuzz EP

ID	BANK B
153	VideoKilledRadio
154	UK Pop CP70
155	MistyMountain EP
156	No Quarter Pnt
157	Black Friday
158	Sly Ballad
159	RoyalKingWakeman
160	Spaced Out Bach

# ORGAN 1

---

ID	BANK A
33	Classic B3
34	Funky Perc
35	Soul Perc
36	First Three
37	PerfectStrangers
38	'70s Drawbars
39	Progbars
40	Ezra II

ID	BANK B
161	Ezra's Burner
162	Classic Traffic
163	Mr Smith
164	HotTubeGospel
165	VASTBars1-3,8&9
166	Doors Vox
167	Animals Vox
168	Combo Organ

# ORGAN 2

ID	BANK A
41	All Stops
42	AllStops AllVox
43	Pipe Stops
44	Chapel Organ
45	Pipes & Voices
46	16' Open Flute
47	16' Ped Reed
48	16' Reed A

ID	BANK B
169	16' Viol
170	LateNighter
171	Testify
172	The Ninth Bar
173	Blues Harmonica
174	ParisCmboAccordn
175	MellowAccordion
176	BrazilAccordion

# CLAVINET

ID	BANK A
49	Black Cow Clav
50	Crisp Clav
51	RealSupasticious
52	Joe's Clav
53	Rufus/Marley WAH
54	Hiya Ground sw
55	TrampledUnder D6
56	HeartbreakerWAH

ID	BANK B
177	SailinShoes Clav
178	Shoobie Model C
179	Stevie Fuzz
180	StopMakingSense
181	Mutron+Synth sw
182	EvilWomanDeepFuz
183	Harpsichord
184	StBaroque Harpsi

# BRASS/WINDS

ID	BANK A
57	Session Hornz
58	High-End Horns
59	Split SectionSW
60	Mancini Brass
61	Mostly Saxes
62	GB Hornz+Syn
63	Super-8 Brass
64	Brass Fanfare

ID	BANK B
185	Low Orch Brass
186	Bassoon/Oboe
187	Lead Trumpet
188	Solo Trombone
189	Solo Alto Sax
190	Solo Tenor Sax
191	Flute/Clarinet
192	Solo Bari Sax

# STRINGS

---

ID	BANK A
65	Adagio Strings
66	Big LA Strings
67	Fast Strings
68	Slow String Trem
69	AdagioTutti 8ves
70	Adagio Octaves
71	NashvilleStrings
72	Poltergeist Pad

ID	BANK B
193	Full Pizzicato
194	Winds & Strings
195	Gothic Climax
196	Yesesis Tron Str
197	3Way Split Mltrn
198	Solo Violin fast
199	Solo Cello fast
200	Solo Harp

# VOICES

---

ID	BANK A
73	Mixed Choir
74	Manhattan Voices
75	Choir Complete
76	NYC in LA
77	Crystal Voices
78	Cathedral Vox
79	Silent Sorrow
80	Swept Tron Voice

ID	BANK B
201	Slo Orch Chorus
202	Aaah Vocals
203	Jazzy Ballad Vox
204	Bright Syn Vox
205	AntiqueAhhChorus
206	Vox Orgel
207	Aaahlicious
208	PolyTechnobreath

# SYNTHS

---

ID	BANK A
81	Super Saw
82	Classic SynBrass
83	80's Heaven
84	80's Lead Synth
85	PolySynth Stack
86	Chillwave Chords
87	Dark Wobbles
88	Classic Saws

ID	BANK B
209	Big Old Jupiter
210	Punchy Synth
211	Touch Trance
212	Minipulse 4Pole
213	FrankensteinWah
214	Grudge Lead
215	Square Bell
216	Daft Lead

# PADS

ID	BANK A
89	Film Score Pad
90	MW S&H Filt
91	Runner Pad
92	Majestic Pad
93	So Lush Pad
94	Undercurrents
95	Fairlight Pad
96	Phase Shimmer

ID	BANK B
217	Evolving Pad
218	Lush Pad
219	Deeper Water
220	Lush Rhythm Pad
221	Cosmic Sus Pedal
222	Slo Syn Orch
223	Add A Pad 1
224	Add a Pad 2

# GUITAR

ID	BANK A
97	Rich 'Caster
98	Rich Les
99	SuperStudioCast
100	PhasePickLes
101	TimeWarpCaster
102	Kinda Krunchy
103	Brown Sound
104	RedHot/StudioStr

ID	BANK B
225	SuperflyWahCast
226	Jack the Ripper
227	Raw & Bleedin'
228	Boutique Six Str
229	Boutique 12 Str
230	3Str Mandolin
231	3Str Banjo
232	Dulciliere

# BASS

ID	BANK A
105	P-Bass
106	Motown Bass
107	E-Bass
108	Flea/Bootsy
109	Jaco Fretless
110	Noise Bass
111	AC Buzzer Bass
112	Woodhouse Bass

ID	BANK B
233	Aggro OctoBass
234	KneeDeepMinimoog
235	Squeeze Mini
236	Iceman Bass
237	ANGRYBass
238	Big Synth Bass
239	The Way It Is
240	Bass Pedal

# DRUMS

---

ID	BANK A
113	Kit 1 Open Rock
114	Kit 2 J Geils
115	Kit 3 West Boxy
116	Kit 4 SquashRock
117	Kit 5 Beatbox101
118	Kit 6 Full Room
119	Kit 7 Brush
120	Kit 8 CopperRing

ID	BANK B
241	Kit 9 Big Buzz
242	Kit 10 DeadRockr
243	Kit 11 Low Rock
244	Kit 12 GaddsLair
245	Kit 13 KirkeeB
246	Kit 14 ModernRok
247	Kit 15 Drum&Bass
248	Kit 16 Skrlx

# PERCUSSION

---

ID	BANK A
121	Celeste
122	Chimes/Glock
123	Real Vibes
124	Stereo Marimba
125	Xylophone
126	XHarmonicStlDrum
127	Carillon
128	Natural Perc

ID	BANK B
249	Percussionist
250	Basic Orch Perc
251	PERC Carnival
252	VRT Accessory
253	VRT BongoConga
254	VRT TalkingDrum
255	Vocal Percussion
256	Orch Timpani

# Appendix D

## Factory Multis

ID	MULTI
1	Concert Piano SE
2	Rock Piano SE
3	Jazz Piano SE
4	Pop Piano SE
5	Upright Piano SE
6	Bright Piano SE
7	R&B Piano SE
8	Distant Piano SE

ID	MULTI
9	Bell EP SE
10	Dyno EP SE
11	ACL EP SE
12	Vagrant SE
13	FM E. Piano SE
14	Pop CP70 SE
15	Phase Clav SE
16	Rich 'Caster SE

ID	MULTI
17	Futurescape
18	Daft Wobbles
19	Funky Bass Split
20	Introspektakular
21	Xenopad
22	EDMkit/Wobble
23	Solaris Pad
24	Massive Mono

ID	MULTI
25	Velociraver
26	BendAway Bass
27	Chill Kit/Chords
28	Futurebeats
29	Electro Kit/Lead
30	Lead Fifths
31	Vibsey Pad
32	Super Duper Saw

ID	MULTI
33	Piano, Steel+Pad
34	Metal Bass/Gtr
35	Universe Pad
36	Triumphant!
37	Daydream EP
38	Cartoon Pizz
39	Euro Chords
40	Distorted Stack

ID	MULTI
41	CP, FM & Pad
42	Piano +Gtr +Pad
43	Endless Dream
44	EP & Synbass
45	Big Choir 5ths
46	Plucked Sus Strs
47	Alien Choir
48	Sneaky Strings

## Factory Multis

---

ID	MULTI
49	Synth & Strings
50	Pizz & Glock
51	Lotsa Horns
52	Jungle Marimba
53	ClavWithBenefits
54	Pad Organ
55	Organ and EP
56	The 9th Circle

ID	MULTI
57	Big Bottom Piano
58	Piano & Stuff
59	Piano, Dulci+Pad
60	Kurzland Report
61	Bass Piano Vibes
62	ETtheExistential
63	RoboPiano
64	Indy Strings

ID	MULTI
65	Samba Layers
66	Gtr Pno Pad Stck
67	Dirty FM
68	Fuzz Echo
69	Smooth Dirt
70	EP Echoes
71	Analog vs Digi
72	Psychedelic EP

ID	MULTI
73	CP70 & Harpsi
74	Funked up Clav
75	CP Pad & Choir
76	Fusion Split
77	Vicious Organ
78	Plucked B3
79	Organ Strings
80	Organ Choir

ID	MULTI
81	Organ 16s
82	FM Pad Bell
83	Big Synth
84	Chime Pad
85	Harpsipad
86	Mellow Pad
87	Power Pad
88	Edgy Organ Pad

ID	MULTI
89	Dist Bass & Pad
90	SailinClav Pad
91	Cloudwalk
92	Quake
93	Lead Everything
94	Dont Push Me
95	Reflecting Lead
96	Piercing Lead

ID	BANK A
97	Hungry Lead
98	Fairytale
99	Lost In Space
100	Popstep
101	Saw 5ths
102	Trill Singers
103	Vox n Bells
104	3 Layer Stack

ID	BANK B
113	Shimmer
114	Dulci & 12String
115	Guitarmageddon
116	Feel Electric
117	Mallet Palette
118	Jungle Floor
119	Rock the Bells
120	Enchanted Forest

ID	BANK A
105	Real+Tape Strngs
106	Harp n Orchestra
107	Horror SndTrack
108	Klezmer
109	String Quartet
110	Hip Hop Strings
111	Hybrid Horns
112	Space Brass

ID	BANK B
121	Dark Pad w Bells
122	Squeaky E. Drums
123	Perc and Bells
124	World Perc
125	Timp and Perc
126	Worship
127	Icy Chill
128	Submerged Piano



# Index

## A

Alpha Wheel 2-2, 3-11, 3-12, 6-2, 6-3, 7-2, 7-3, 7-8, 8-4.  
 Assign 3-2, 3-14, 6-8, 7-6, 8-5.  
 Audio Cables 2-2, 2-5, 12-3.  
 Audio In 3-4, 3-6.  
 Audio Jacks 2-5, 3-4.  
 Audio Problems 12-2.  
 Auto Power Off 9-4.  
   Time 9-4.  
 Aux Effects  
   Channel 8-15.  
   Send level 8-7.

## B

Balanced Cable 2-2, 2-5.  
 Bank  
   Change 8-8, 9-6.  
   MIDI 4-2, 8-8.  
   Select Button 3-2, 3-11.  
 Bend 3-3, A-1.  
   Bend Range Down 3-3, 3-15, 8-10.  
   Bend Range Up 3-15, 8-10.  
 Bootloader (System Mode) 11-1.  
 Buttons  
   Assign 3-12.  
   Category 2-2, 3-2, 3-10, 6-1, 6-2, 6-4, 6-5, 7-2, 7-4.  
   Double Press  
     Demo 3-14.  
     Panic 6-11.  
     Parameter Jump 3-13.  
     Program Demo 3-14, 6-2.  
     Reset Transposition 3-13.  
     Value Jump 3-12, 3-13, 6-3, 6-7, 6-9, 7-3, 7-6, 7-7.  
   Exit 3-2, 3-12.  
   Filter-FX 3-2, 3-6.  
   Global 3-7.  
   Multi 3-7, 5-1, 7-1.  
   Mute. *See* Zone: Muting.  
   Next (+) 2-2, 6-2, 7-2.

Param/Channel 3-11, 3-12, 5-3, 6-10.  
 Param Jump 8-4.  
 Previous (-) 2-2, 3-2, 6-3, 6-5, 7-3, 9-3.  
 Program 3-7, 5-2, 6-1.  
 System Mode 11-2.  
 Value 3-12, 6-3, 7-3.  
 Value Jump 8-4.  
 Zone 3-6, 7-2.

## C

Category Buttons 2-13, 3-10, 6-1, 7-2, 7-3.  
 Category Default. *See* Default (Category).  
 CC Jack 1-2, 2-4, 2-7, 2-9, 2-10, 3-3, 12-6.  
 Channel 3-1, 3-7, 3-11, 3-12, 4-1, 4-2, 5-1, 6-1, 6-10, 6-11,  
   7-1, 8-15, 9-6, 9-7, 12-4, A-1, B-1.  
   Effects 8-7.  
 Common parameters 8-3, 8-15.  
 Connecting Audio 2-2, 2-5.  
 Connecting MIDI 2-4, 2-10 to 2-11.  
 Connecting Pedals 2-4, 2-6, 12-5.  
 Continuous (Control) Pedals 2-7, 2-10, 3-4, 12-5, 12-6.  
 Contrast Knob 12-2, B-1.  
 Controller 1-1, 1-2, 2-3, 2-4, 2-11, 2-12, 2-13, 3-7, 3-8,  
   3-14, 3-15, 4-2, 5-1, 5-2, 6-6, 6-8, 6-10, 6-11, 7-1,  
   7-6, 7-8, 8-8, 9-7, 12-3, 12-6, A-1.

## D

Default (Category) 3-13, 6-3, 6-5, 7-1, 7-2, 7-3, 7-4.  
   Choosing 6-5, 7-4.  
 Default (Power Up) 3-1.  
 Delete  
   Objects 9-8.  
 Demo Function 3-14, 5-3.  
 Demo Song 3-14, 5-3, 6-2.  
 Destination  
   Local 12-3, A-1.  
   MIDI 8-6.  
 Device 10-1.  
 Diagnostics 11-4, 12-7.  
 Display 3-2, 3-8, 3-11, 6-2, B-1.  
   Contrast Knob 12-2, B-1.  
   Problems 12-2.  
 Double Button Presses 3-13, 6-3, 7-3.  
 Dual Switch Pedal 2-4, 2-7, 2-8, 2-9, 12-5.

## Index

---

### E

Edit Button 3-7, 5-2.  
Editing Parameters 3-13, 3-15, 6-7, 6-9, 7-7, 9-2.  
Effects B-1.  
    Aux 8-15.  
    Aux Override B-1.  
Entry 8-6, 8-7.  
    Continuous controller 8-13.  
    Pan 8-7.  
    Pedal switch 8-14.  
    Program Change 8-2, 8-10.  
Entry Volume 8-6.  
Exit 3-2.  
Exit State  
    Continuous controller 8-13.  
    Pedal Switch 8-14.  
    Program Change 8-13.

### F

Factory 1-2, 2-13, 3-1, 3-7, 4-2, 4-3, 5-2, 6-1, 6-2, 6-3, 7-1, 7-2, 7-8, 8-15, 9-1, 12-6, 12-7, B-1.  
Favorite Buttons 3-1, 3-10, 6-2, 6-5, 7-2, 7-4.  
Features 1-1, 3-1.  
Feet (Rubber) 1-3, 2-1.  
Files 12-6.  
    Delete All 12-6.  
    Loading 5-2.  
    Load (Overwrite) 10-4.  
    Saving 10-2.  
File Utilities 11-4.  
Flash Drive. *See* USB Flash Drive.  
Format  
    system flash memory 11-4.  
Front Panel 2-2, 2-13, 3-2, 3-5, 3-6, 3-11, B-1.  
Function buttons 3-8.  
Functions 5-3.  
    Demo. *See* Demo Function.  
    Layer. *See* Layer: Function.  
    Split. *See* Split: Function.  
FX Select 9-4, A-1.  
    Filter-FX switch 3-6.

### G

Getting Started 2-1.  
Global Button 3-7.  
Global Mode 3-1, 3-7, 3-12, 3-13, 4-2, 4-3, 5-1, 5-2, 6-11, 9-5.  
Global Parameters 5-2, 9-2, 9-3, 9-5.

### H

Half Damper Pedal 2-7. *See* Pedal: Half Damper.  
Hard Reset 3-7, 4-2, 5-2, 9-1.  
Headphones 2-2, 2-5, 2-6, B-1.  
High Key 8-7.  
High Velocity 8-8.

### I

ID numbers  
    Controller destinations 8-11.  
ID Numbers 6-2, 6-11, 6-12, 7-2, 7-8.

### K

K2600 Bank mode 8-10.  
KB3 Channel 8-16.  
KB3 Programs 4-2.  
    Controls 3-3, 3-6.  
Keyboard 1-2, 2-1, 2-2, 3-6, 3-8, 4-1, 4-2, 5-1, 6-6, 6-8, 7-1, 7-4, 7-5, 7-6, 8-8, 9-6, 9-7, B-1.  
Knob 3-6, 12-2.  
KUF File 4-3, 11-2.

### L

Layer 4-2.  
    Button 3-7, 3-9.  
    Function 3-9, 4-2, 5-3, 6-8, 6-9, 6-10, 7-6, 7-7.  
    Program 6-9, 6-10, 7-7.  
    Transposition 6-10, 7-7.  
    Volume 6-9, 7-7.  
LED 3-4, 3-6, 3-7, 3-8, 3-9, 6-1, 6-4, 6-5, 6-6, 6-11, 7-1, 7-2, 7-4.  
Load  
    (Fill) 10-4.  
    (Overwrite) 10-3.  
    PC 2-13, B-1.  
    USB 1-3, 2-3, 2-13, 9-4, B-1.  
Local Keyboard Channel 9-6, 9-7.  
Local Program 8-5.  
Low Key 3-15, 8-7.  
Low Velocity 8-8.

### M

Maintenance 12-1.  
Master EQ 3-2, 3-4, 3-5, 3-6.  
MIDI 1-1.  
    Bank. *See* : MIDI.  
    Bank Change Messages 8-8, 8-10.  
    Bank changes 9-6.  
    Channel 3-1, 3-7, 3-13, 4-1, 4-2, 5-1, 6-1, 6-10, 6-11, 8-15, B-1.  
    Channel Enable 6-11, 9-6.

Channel Transmit 3-12, 6-10, 7-1, 8-6, 12-4.  
 Connecting. *See* Connecting MIDI.  
 Implementation Chart A-1.  
 Ports 2-4, 2-11.  
 Problems 12-4.  
 Program Change 8-9, A-1.  
 MIDI Program 8-9.  
 Mode 2-2, 3-4, 3-10, 3-12, 4-2, 5-1.  
 Buttons 2-2, 3-2, 3-6, 5-1, 5-2, 6-1, 7-1.  
 Multi 2-7, 3-1, 3-3, 3-7, 3-8, 3-9, 3-12, 3-13, 4-1, 5-1, 5-2,  
 5-3, 6-6, 6-8, 6-9, 6-10, 7-1 to 7-9, 9-7.  
 Multi Edit 3-8, 3-11, 3-13, 3-14, 3-15, 5-2, 5-3, 6-8, 6-9,  
 8-1, 9-7, 12-3.  
 Program 3-1, 3-3, 3-7, 3-8, 3-13, 3-14, 5-1, 5-2, 5-3, 6-1 to  
 6-12, 8-15, 12-1.

#### Modes

Global 9-1.  
 Storage 10-1.  
 System 11-1.  
 Mod Wheel 1-2, 3-2, 3-3, 3-15, 4-1, 5-2, 6-6, 9-7.  
 Mono 2-2, 2-5, A-1.  
 Mono Switch Pedal 2-7. *See* SW1 and SW2 Pedal.  
 Multi Edit Mode 3-8, 3-11, 3-13, 3-14, 3-15, 5-2, 5-3, 6-6,  
 6-8, 6-9, 6-10, 7-5, 7-6, 7-7, 7-8, 9-7, 12-3.

Display 8-4.  
 Multis 2-13, 3-7, 4-1, 5-1, 7-1 to 7-9, D-1.  
 Editing. *See* Multi Edit Mode.  
 Favorites 7-4. *See also* Favorite Buttons.  
 Parameters List 8-2.  
 Saving 6-8, 6-10, 7-6, 7-8.  
 Zones. *See* Zone.  
 Muting Zones 1-2, 2-4, 7-2, 8-6.

## N

Naming 6-2, 6-11, 6-12, 7-2, 7-8, 7-9.  
 Navigation 3-2, 3-11.  
 Notemap 8-8.

## O

Objects 4-3.  
 Deleting All 12-6.  
 Loading. *See* : Loading.  
 Saving 10-2.  
 Version 9-7.  
 Octave Button 3-9.

## P

Panic 3-14, 12-3. *See also* Buttons: Double Press: Panic.  
 Param/Channel Buttons 3-2, 5-3, 8-2, 8-4. *See* Buttons:  
 Param/Channel.  
 Param Jump 8-4.

Parameter 7-6.  
 List 3-12.  
 Parameter Assignments 6-6.  
 PC 2-13, B-1.  
 Pedal 1-2, 1-3, 2-4, 2-7, 2-8, 2-9, 2-10, 2-13, 3-1, 4-1, 5-2,  
 12-5, 12-6, C-5.  
 Dual Switch 2-4, 2-7, 2-8, 12-5.  
 Half Damper 2-4, 2-9, 12-5.  
 Pedal Noise 9-4.  
 Pitch Wheel 3-2, 3-3, 3-15, 8-10.  
 Power ii, iii, 3-1, 6-7, 6-9, 7-5, 7-7, 9-4, 12-1, 12-2, 12-5,  
 B-1.  
 adapter 2-2, 2-5.  
 Problems 12-1.  
 Power Cable iii, 1-3, 2-5.  
 Power Off. *See* Auto Power Off.  
 Program 2-2, 2-13, 3-7, 4-1, 5-1, 6-1 to 6-12.  
 Favorites. *See* Favorite Buttons.  
 List C-1.  
 Mode 5-2, 9-4, 9-6. *See* Mode: Program.  
 Parameter 8-13.  
 Saving 6-11.  
 Selection 2-13, 6-1, 6-4.  
 Program Change 8-10, 9-6.

## R

Real Time Control 3-3.  
 Rear Panel Connections 1-2, 2-3, 2-5, 2-7, 2-9.  
 Reset  
 Hard 3-7, 4-2, 5-2.  
 Soft 3-7, 4-3.  
 System 11-4, 12-6.  
 Restore 11-3. *See also* Reset.  
 Rubber Feet. *See* Feet (Rubber).  
 Run 11-2.

## S

Save. *See* MIDI: Saving; *See* : Saving; *See* Store.  
 Button 3-6, 3-8.  
 Saving  
 All Objects 10-2.  
 Selecting  
 Modes. *See* MIDI: Buttons.  
 Objects. *See* : Selecting.  
 Sliders 1-2, 2-13, 3-5, 3-6, 3-8, 4-1, 5-2, 6-6, 9-7, 12-6.  
 Soft Reset 4-3, 5-2, 9-5. *See also* : Soft.  
 Software  
 Restore 11-3. *See* Restore.  
 Update 11-2. *See* System Update.  
 Sostenuto 1-2, 2-4, 2-7, 2-9, 3-4, 8-12, 12-5.  
 Sound  
 Button 3-8.

## Index

---

Specifications B-1.  
Split 4-2.  
  Button 3-8, 6-6, 7-5.  
  Function 3-8, 4-2, 5-3, 6-6, 6-7, 6-8, 6-10, 7-5.  
  Key 3-15, 6-8, 7-6.  
  Program 6-6, 6-7, 6-8, 7-5, 7-6.  
  Transposition 6-8, 7-6.  
  Volume 6-7, 7-6.  
Storage  
  Button 3-7.  
  Device 10-1.  
  Mode 5-2, 10-1.  
Store 10-2.  
Support 2-4, 2-8, 12-6.  
Sustain 1-2, 2-4, 2-7, 2-9, 3-4, 8-12, 12-5.  
SW1 and SW2 Buttons 3-3, 8-13. *See also* Switch Buttons.  
SW1 and SW2 Pedal 2-4, 2-7, 2-8, 2-9. *See also* Pedal.  
Switch 1-2, 2-7, 3-8.  
Switch Buttons 3-2, 3-3, 3-15, 4-1, 5-2, 6-6.  
Switch Pedal 1-2, 2-4, 2-7, 2-8, 2-9, 3-4, 12-5. *See also* Pedal.  
Sysex ID 9-7.  
System Mode 11-1, 12-7.  
System Update 1-3, 2-3, 4-3, B-1.

## T

Tablet 1-3, 2-3, 2-12.  
Thumb Drive. *See* USB Flash Drive.  
Transpose. *See also* Layer: Transposition; *See also* Split: Transposition.  
  Buttons 3-9, 6-5, 6-6, 7-4.  
  Reset 3-9, 3-13, 6-5, 7-4.  
  Zones 7-4, 8-7.  
Troubleshooting 12-1, 12-7.  
Tuning 3-7, 3-9, 6-5, 7-4, 9-3, A-1.

## U

Update 2-3.  
Update software 11-2.  
USB Flash Drive 2-3.  
USB MIDI 9-4.  
USB Port 2-3, 2-13, 11-2.  
User Button 3-10, 6-3.  
User Multis 6-6, 8-16.  
  Saving 7-8, 8-16.  
User Objects  
  Deleting all 11-2, 11-4.  
  Saving all 10-2.  
User Programs 6-6, 6-11.

## V

Value Jump Buttons 8-4.  
Velocity 3-1, 3-7, A-1, B-1.  
Velocity Maps 3-1, 9-3.  
Volume 6-7, 6-9, 7-6, 7-7, 12-6, B-1.  
  Slider 2-2, 3-2, 3-4.

## Z

Zone 1-2, 2-7, 3-4, 3-6, 3-11, 3-14, 3-15, 4-1, 4-2, 5-1, 6-6, 6-8, 6-9, 6-10, 7-1, 7-1 to 7-6, 8-1, 9-6, 9-7, 12-4.  
  *See* Zone: Muting.  
  Channel Effects 8-7.  
  Edit 8-5, 8-7.  
  Muting 1-2, 3-2, 7-2. *See* Muting Zones.  
  Status 8-6.  
  Volume 3-2.  
Zones 7-1, 7-5, 7-7, 8-6.  
  Parameters 8-5.